

VERGIN : We are LOCAL & Bright



Scan to Connect



S.D. Electricals Ahmedabad.

Authorised dealer/Channel Partner



✉ customersupport@verginelectric.com

🌐 www.verginelectric.com

▶ Vergin Electric

📘 facebook : vergin electric

📷 instagram : vergin_electric

▶ youtube : vergin electric

Legal Notice :

All rights reserved. The Content of this brochure is subject to change without prior notice. All image, Statements, designs, offerings included in this brochure are of the company. The Company reserves its rights to suitably Change, alter or omit anything contained herein. for suggestions and/or complaints send & email to customersupport@verginelectric.com

AN ISO 9001:2015 CERTIFIED COMPANY



One Brand • One Stop
ONE SOLUTION

1500+ Products



LED's • Switches • Accessories • Wires • MCB's

AN ISO 9001:2015 CERTIFIED COMPANY



Mr. ANIL LALWANI (Director)
VERGIN ELECTRICAL ACCESSORIES, Ahmedabad.



ABOUT US

VERGIN ELECTRICAL ACCESSORIES is established in 1999, an "ISO 9001:2015" certified manufacturing company. We are leading manufacturer company of Electrical Products like Wires, Leds and many more items which is based in Ahmedabad, Gujarat. We manufacture more than 1500 products which has huge range in our industry. Our Strength is our staffs their smart work has made possible, which enlarge our employee strength from 25 to 350 in a short duration of time.

OUR MISSION

With all the support and positive feedback from the people, "VERGIN" has grown as a brand in the past few years. It's our mission to achieve zero emission and sustainable growth, a much needed all over the world. Here, we are working to make all types of electrical goods in better quality. In future, one can open or convert their stores in one brand i.e. VERGIN; the complete solution of all your electrical problems. Our Mission is to achieve a benchmark globally by Dec-22 and we are 24 x 7 working on it. We are true example of putting words into action on how the energy transition can succeed sustainably through digital energy management.

OUR VISION

Our vision statements also define our company purpose, the focus on its goals and aspirations. These statements are designed to be uplifting and inspiring. They are also timeless even if the company changes its strategy. Because we manufacture all types of products in our nation. To make our nation more brighter than others. And all of these products are highly energy efficient, which eventually help to create a clean, green, and healthy environment in every segment of the society. The company has successfully manufactured the high brightness LED lights in urban areas as well as rural areas, outdoor led lights, and indoor lighting in homes and offices. To produce the highest quality products at the minimum cost and deliver them to the customer on time. "A promise made is a promise kept".

QUALITY ASSURANCE SYSTEMS

- To ensure performance, longevity and customers satisfaction, consistently conducts tests to guarantee LED reliability.
- Each phase of our manufacturing process undergoes high quality control to deliver the best results.
- The first step to assuring quality starts with exceptional supplier quality management.
- New batches of supplied materials are confirmed, examined and inspected. This process allows LED to utilize high-quality components to manufacture top of the line fixtures.
- Once assembled, fixtures are individually tested to ensure proper functionality. Components are designed and tested to meet public safety standards. Even before and after packing, LED lights go through additional rounds of testing. The purpose of BIS is to examine the samples of products.
- Our full spectrum approach guarantees quality at every turn, which in turn delivers quality directly to customers.

FASTEST

We Believe In Build a Large Network

GROWING

We Believe In Quality Products

COMPANY

We Believe In Customer Satisfaction



ANNOUNCING
AN EXCLUSIVE
EXPERIENCE

Trendy
Modular Series

NEW

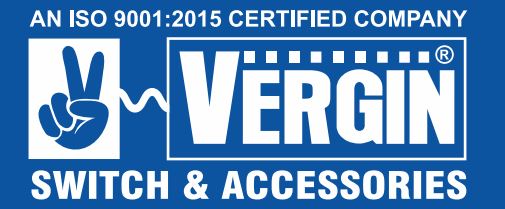

**LEAVE
THE
ORDINARY
BEHIND**

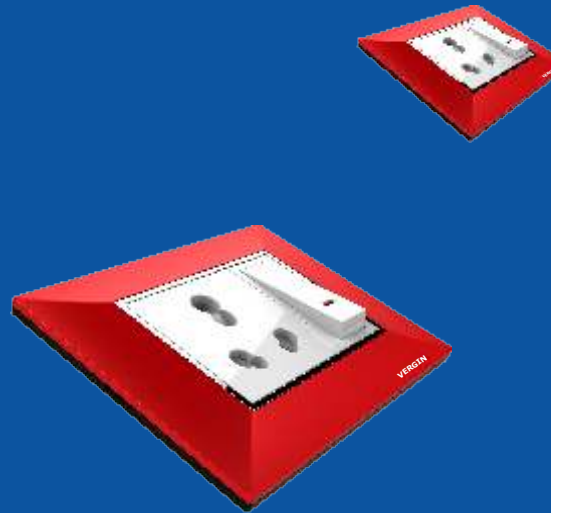

Trendy
Modular Series

**SWITCH
& ACCESSORIES**

TRENDY MODULAR SERIES

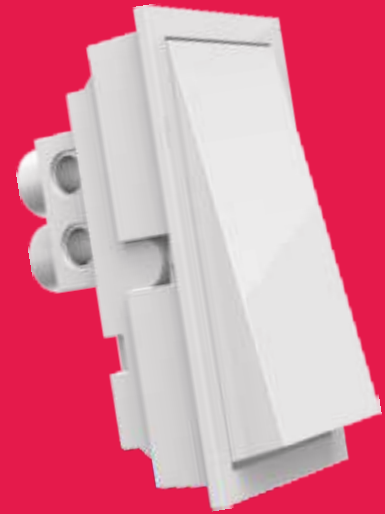

REAL
CLICK SWITCHES

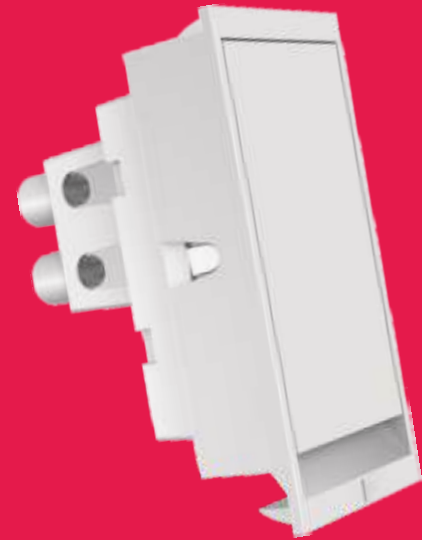

FLAT
CLICK SWITCHES



SILVER
CLICK SWITCHES

REAL CLICK SWITCHES

YOUR WORLD
AT YOUR FINGER TIPS



5001 5002 5003 5004

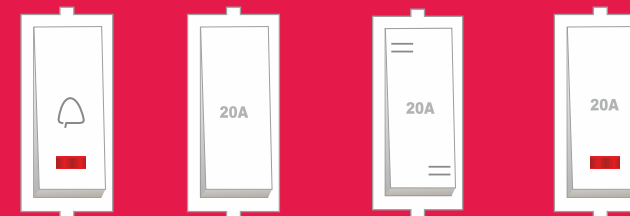

5005 5006 5007 5008



5011 5012 5013

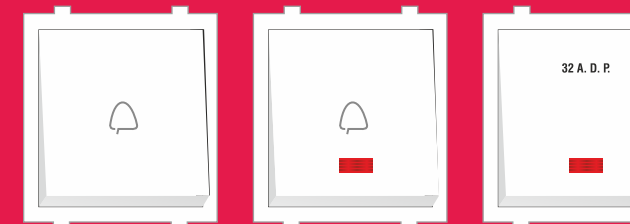

5014 5015 5016

CODE	DESCRIPTION	MRP	MRP	Pkg.
		WHITE	METALLIC GREY MATT BLACK	
1 MODULE REAL CLICK SWITCHES				
5000	6A. 1 Way Switch	56.00	-	20
5001	10A. 1 Way Switch	63.00	69.00	20
5002	10A. 2 Way Switch	86.00	95.00	20
5003	10A. Bell Push Switch	86.00	95.00	20
5004	10A. 1 Way Switch with indicator	86.00	95.00	20
5005	10A. Bell Push with indicator	99.00	109.00	20
5006	20A. 1 Way Switch	93.00	103.00	20
5007	20A. 2 Way Switch	118.00	130.00	20
5008	20A. 1 Way Switch with indicator	115.00	127.00	20
5009	25A. 1 Way Switch (Porcelain Base)	118.00	130.00	20
2 MODULE REAL CLICK SWITCHES				
5011	20A. 1 Way Switch	133.00	147.00	10
5012	20A. 2 Way Switch	171.00	188.00	10
5013	20A. 1 Way Switch with indicator	141.00	156.00	10
5014	10A. Bell Push Switch	112.00	123.00	10
5015	10A. Bell Push Switch with indicator	119.00	131.00	10
5016	32A. 1 Way Switch with indicator	291.00	332.00	10

FLAT CLICK SWITCHES

SIMPLE SOLUTION
FOR BETTER HOMES

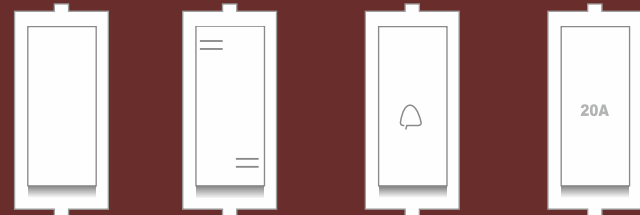
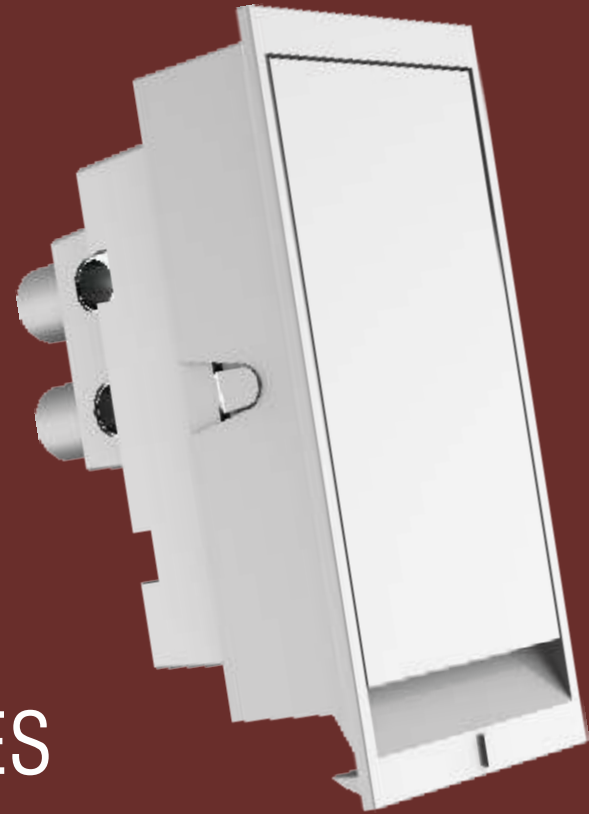

5031 5032 5033 5034

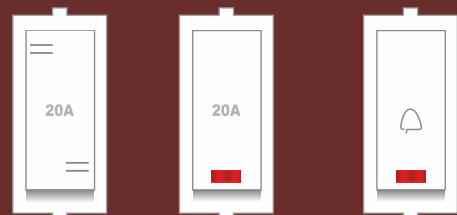

5035 5036 5037

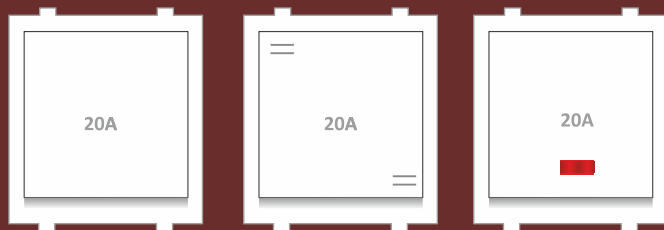

5041 5042 5043

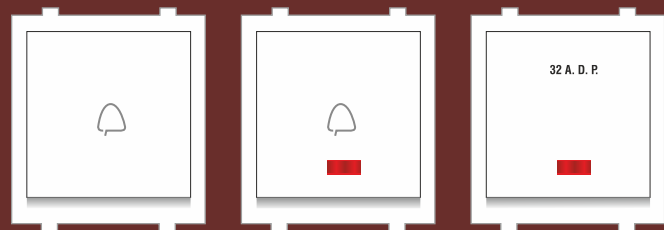

5044 5045 5046

CODE	DESCRIPTION	MRP	MRP	Pkg.
		WHITE	METALLIC GREY MATT BLACK	
1 MODULE FLAT CLICK SWITCHES				
5031	10A. 1 Way Switch	64.00	70.00	20
5032	10A. 2 Way Switch	87.00	96.00	20
5033	10A. Bell Push Switch	87.00	96.00	20
5034	20A. 1 Way Switch	94.00	103.00	20
5035	20A. 2 Way Switch	120.00	132.00	20
5036	20A. 1 Way Switch with indicator	117.00	129.00	20
5037	10A. Bell Push Switch with indicator	99.00	109.00	20
5038	25A. 1 Way Switch (Porcelain Base)	120.00	132.00	20

2 MODULE FLAT CLICK SWITCHES				
5041	20A. 1 Way Switch	145.00	160.00	10
5042	20A. 2 Way Switch	202.00	222.00	10
5043	20A. 1 Way Switch with indicator	154.00	169.00	10
5044	10A. Bell Push Switch	119.00	131.00	10
5045	10A. Bell Push Switch with indicator	129.00	142.00	10
5046	32A. DP 1 Way Switch with indicator	309.00	361.00	10

MAKING A MAGICAL
DIFFERENCE

SILVER CLICK SWITCHES

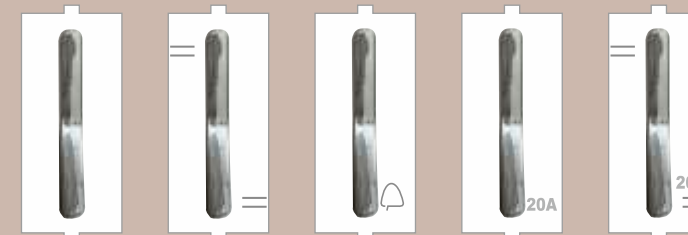

5051 5052 5053 5054 5055

CODE	DESCRIPTION	MRP	MRP	Pkg.
		WHITE	METALLIC GREY MATT BLACK	
1 MODULE SILVER CLICK SWITCHES				
5051	10A. 1 Way Switch	83.00	91.00	20
5052	10A. 2 Way Switch	117.00	129.00	20
5053	10A. Bell Push Switch	117.00	129.00	20
5054	20A. 1 Way Switch	127.00	140.00	20
5055	20A. 2 Way Switch	162.00	178.00	20



TRENDY MODULAR SERIES

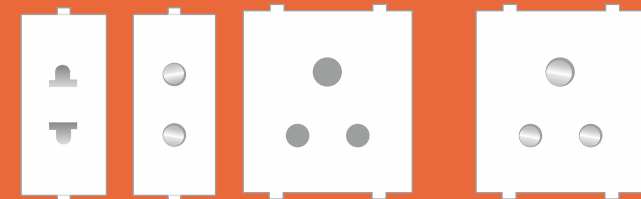

5060 5061 5062 5063

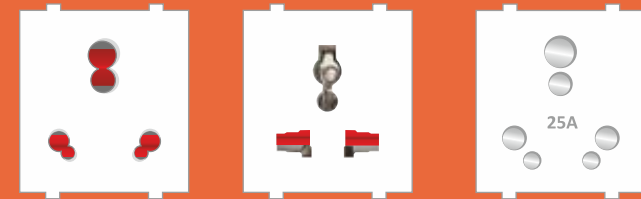

5064 5065 5066

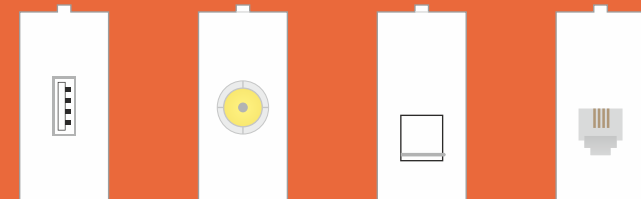

5070 5071 5072 5073

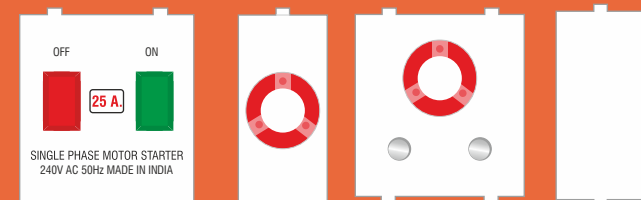

5075 5076 5077 5078

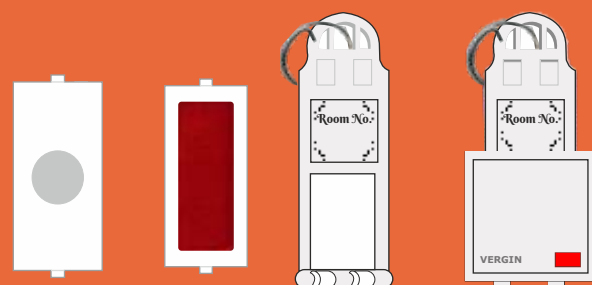

5079 5080 5081 5082

CODE	DESCRIPTION	MRP WHITE	MRP METALLIC GREY MATT BLACK	Pkg.
------	-------------	--------------	------------------------------------	------

6/16A. SOCKET OUTLETS

5060	6A. 2 Pin Socket (With Safety Shutter)	79.00	86.00	20
5061	6A. 2 Pin Socket	63.00	69.00	20
5062	6A. 2 in 1 Socket	95.00	105.00	10
5063	6A. 2 in 1 Socket (With Shutter)	117.00	129.00	10
5064	6/16 A. Uni Socket (With Safety Shutter)	153.00	168.00	10
5065	6/13A. International Socket (With Safety Shutter)	163.00	179.00	10
5066	6/25A. Uni Socket With Porcelain Base	185.00	205.00	10

MODULAR ACCESSORIES

5070	1M USB Charger	480.00	530.00	20
5071	TV Single Outlet	84.00	93.00	20
5072	RJ 11 Tel. Jack with Shutter	91.00	100.00	20
5073	Mini RJ 45 Jack (AT&T) CAT 6	633.00	695.00	10
5075	25A. Sp. Motor Starter	504.00	555.00	20
5076	6A. Round Indicator	88.00	97.00	20
5077	2M 2 Pin Socket Neon Indicator	145.00	160.00	10
5078	1M Blank Plate	21.00	24.00	100
5079	Cord Outlet	68.00	75.00	50
5080	6A. Square Indicator	88.00	97.00	20

5081	Only Key Tag with Key Ring	74.00	82.00	20
5082	32A. DP Main Switch Operating with Key Tag	423.00	465.00	10

THE
EXTRA ORDINARY
IS HERE

TRENDY MODULAR SERIES

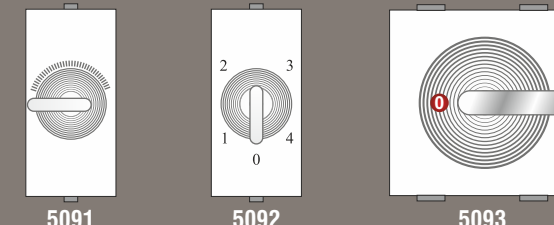

5091 5092 5093

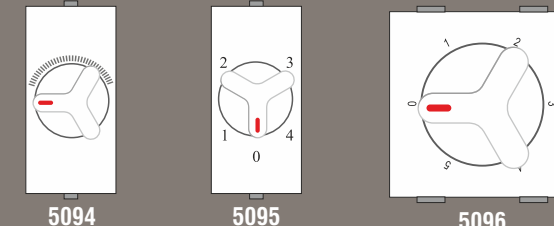

5094 5095 5096

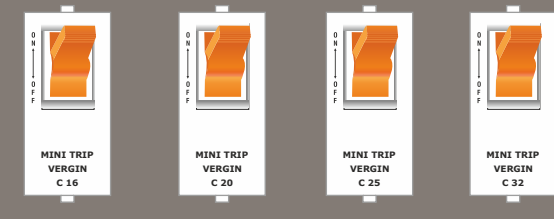

5103 5104 5105 5106

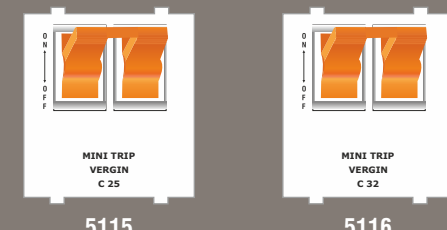

5115 5116



5087 5087

CODE	DESCRIPTION	MRP WHITE	MRP METALLIC GREY MATT BLACK	Pkg.
------	-------------	--------------	------------------------------------	------

FAN REGULATORS

5091	Crista 1M Dimmer	210.00	230.00	20
5092	Crista 1M 4 Step Regulator	250.00	275.00	20
5093	Crista 2M 5 Step Regulator	290.00	320.00	10
5094	Xpress 1M Dimmer	190.00	210.00	20
5095	Xpress 1M 4 Step Regulator	230.00	255.00	20
5096	Xpress 2M 5 Step Regulator	270.00	300.00	10

MCB (Miniature Circuit Breaker) Heavy Duty

5101	6A MCB SP	210.00	230.00	20
5102	10A MCB SP	210.00	230.00	20
5103	16A MCB SP	210.00	230.00	20
5104	20A MCB SP	210.00	230.00	20
5105	25A MCB SP	210.00	230.00	20
5106	32A MCB SP	210.00	230.00	20
5115	25A MCB DP	460.00	505.00	10
5116	32A MCB DP	460.00	505.00	10

MODULAR LED NIGHT LAMP

5087	2M Nexus Down Light	240.00	265.00	10
------	---------------------	--------	--------	----

Available Colours
White • W.White • Blue • Green

MAKE YOUR
LIFE EASY

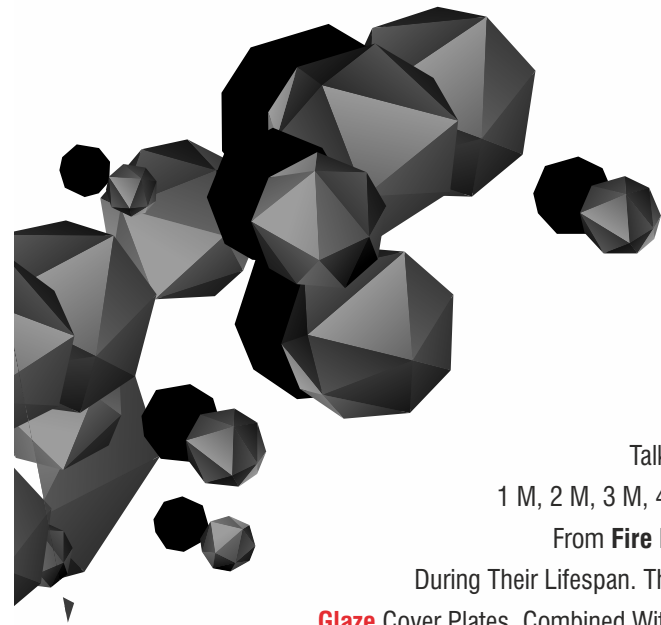

glaze

MODULAR PLATES

Talking About Modular Switch Cover Frames, **Glaze** Offers Them In Module Options Of 1 M, 2 M, 3 M, 4 M, 6 M, 8 M, 12 M, And 18 M Respectively. These Switch Cover Plates Are Made From **Fire Retardant, Uv Stabilized Polycarbonate Material** Which Ensures No Discoloration During Their Lifespan. They Get Fitted In Carefully Designed Assembly Plates Which Fit Tightly On The Wall. **Glaze** Cover Plates, Combined With Inner And Outer Plate, Neatly Cover The Assembly And Get Easily Fit In The Wall.



AN ISO 9001:2015 CERTIFIED COMPANY



TRENDY MODULAR SERIES

GLAZE MODULAR PLATES

White • Metallic • Wood • White (White Border)



glaze

MODULAR PLATES

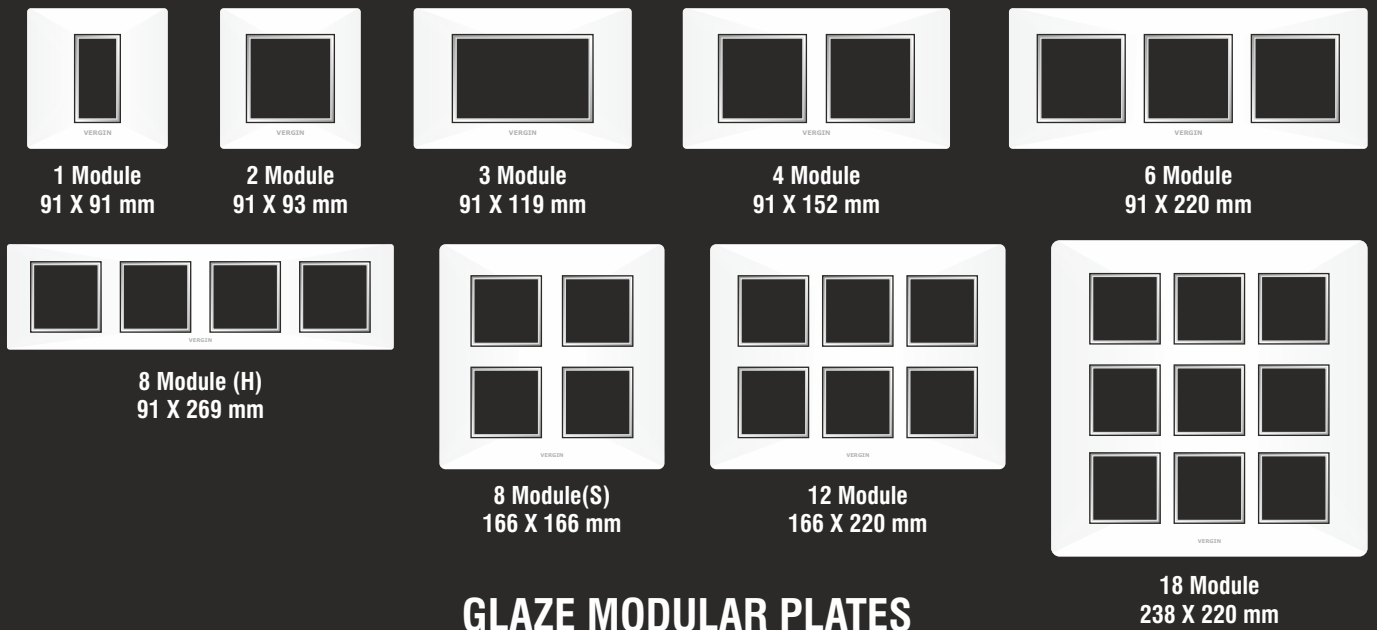

GLAZE MODULAR PLATES

MODULE	1M	2M	3M	4M	6M	8M (Hz.)	8M (Sq.)	12M	16M	18M
CODE	5201	5202	5203	5204	5205	5206	5207	5208	5209	5210
WHITE	76.00	76.00	96.00	113.00	152.00	199.00	199.00	262.00	306.00	333.00
CODE	5211	5212	5213	5214	5215	5216	5217	5218	5219	5220
MATT BLACK	128.00	128.00	158.00	175.00	233.00	318.00	318.00	425.00	468.00	513.00
CODE	5221	5222	5223	5224	5225	5226	5227	5228	5229	5230
RICH WOOD	153.00	153.00	194.00	224.00	314.00	418.00	418.00	522.00	558.00	617.00
CODE	5251	5252	5253	5254	5255	5256	5257	5258	5259	5260
White (White Border)	68.00	68.00	86.00	102.00	137.00	179.00	179.00	236.00	275.00	300.00
PKG.	10	10	10	10	10	05	10	05	05	05

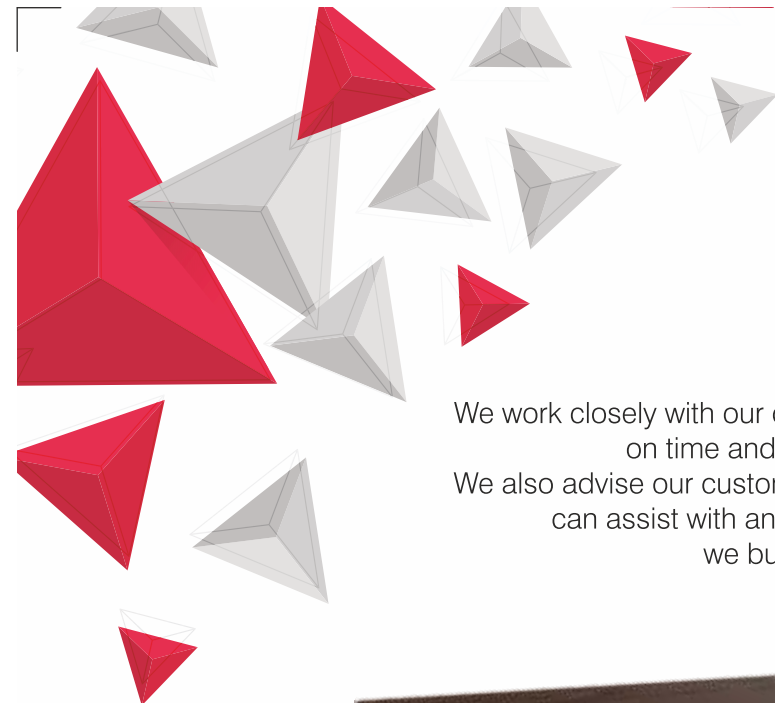

Legend

MODULAR PLATES

We work closely with our customers, ensuring that the task or project is completed on time and on budget, using the highest quality products available. We also advise our customers of any cost saving measure that can be utilized and can assist with any safety requirements. By using our skills and experience we build ongoing and lasting relationships with our customers.



make a life better

AN ISO 9001:2015 CERTIFIED COMPANY
VERGIN
 SWITCH & ACCESSORIES

TRENDY MODULAR SERIES

LEGEND MODULAR PLATES

White • Satin Red • Forest Wood

Legend

MODULAR PLATES



1 Module
91 X 91 mm

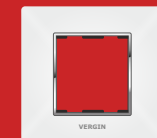

2 Module
91 X 93 mm



3 Module
91 X 119 mm



4 Module
91 X 152 mm



6 Module
91 X 220 mm



8 Module (H)
91 X 259 mm

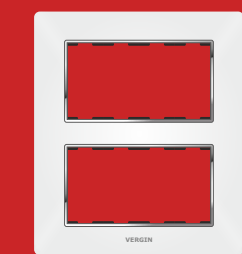

8 Module (S)
166 X 166 mm

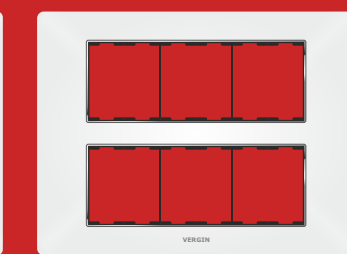

12 Module
166 X 220 mm

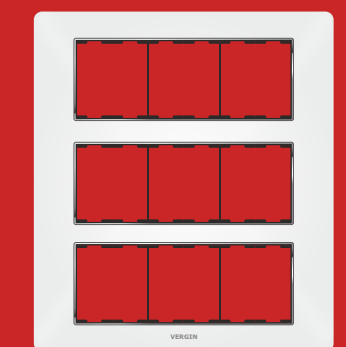

18 Module
238 X 220 mm

LEGEND MODULAR PLATES

MODULE	1M	2M	3M	4M	6M	8M (Hz.)	8M (Sq.)	12M	16M	18M
CODE	5301	5302	5303	5304	5305	5306	5307	5308	5309	5310
WHITE	76.00	76.00	96.00	113.00	152.00	199.00	199.00	262.00	306.00	333.00
CODE	5311	5312	5313	5314	5315	5316	5317	5318	5319	5320
SATIN RED	128.00	128.00	158.00	175.00	233.00	318.00	318.00	425.00	468.00	513.00
CODE	5321	5322	5323	5324	5325	5326	5327	5328	5329	5330
FOREST WOOD	153.00	153.00	194.00	224.00	314.00	418.00	418.00	522.00	558.00	617.00
PKG.	10	10	10	10	10	05	10	05	05	05



RICHNESS
ALWAYS
ATTRACT



SWITCH
& ACCESSORIES

GLASS-X
MODULAR PLATES

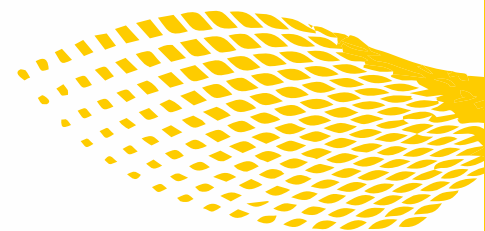

AN ISO 9001:2015 CERTIFIED COMPANY



TRENDY MODULAR SERIES

GLASS-X MODULAR PLATES

Arctic White • Arctic Copper • Arctic Blue • Arctic Black



GLASS-X
MODULAR PLATES

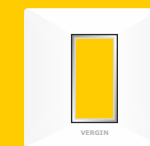

1 Module
91 X 91 mm

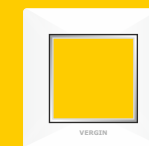

2 Module
91 X 93 mm

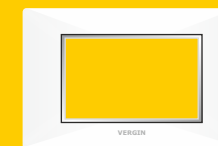

3 Module
91 X 119 mm

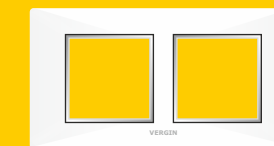

4 Module
91 X 152 mm

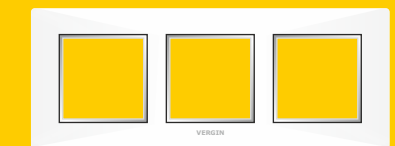

6 Module
91 X 220 mm

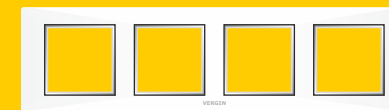

8 Module (H)
91 X 269 mm

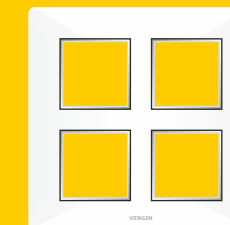

8 Module(S)
166 X 166 mm

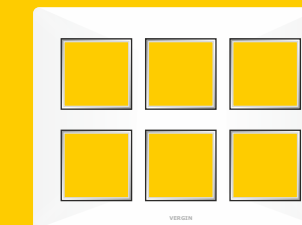

12 Module
166 X 220 mm

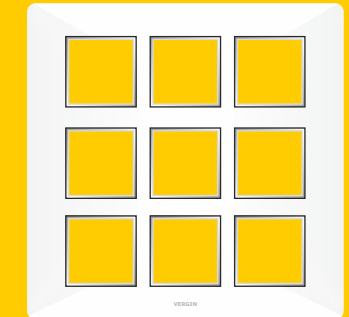

18 Module
238 X 220 mm

GLASS-X MODULAR PLATES

MODULE	1M	2M	3M	4M	6M	8M (Hz.)	8M (Sq.)	12M	16M	18M
CODE	5501	5502	5503	5504	5505	5506	5507	5508	5509	5510
ARCTIC WHITE	190.00	190.00	230.00	270.00	330.00	415.00	415.00	495.00	620.00	695.00
CODE	5511	5512	5513	5514	5515	5516	5517	5518	5519	5520
ARCTIC COPPER	190.00	190.00	230.00	270.00	330.00	415.00	415.00	495.00	620.00	695.00
CODE	5521	5522	5523	5524	5525	5526	5527	5528	5529	5530
ARCTIC BLUE	190.00	190.00	230.00	270.00	330.00	415.00	415.00	495.00	620.00	695.00
CODE	5531	5532	5533	5534	5535	5536	5537	5538	5539	5540
ARCTIC BLACK	190.00	190.00	230.00	270.00	330.00	415.00	415.00	495.00	620.00	695.00
PKG.	10	10	10	10	10	05	10	05	05	05

DRIVE
DEEP
IN TO
COMFORT

FRIENDLY & RELIABLE

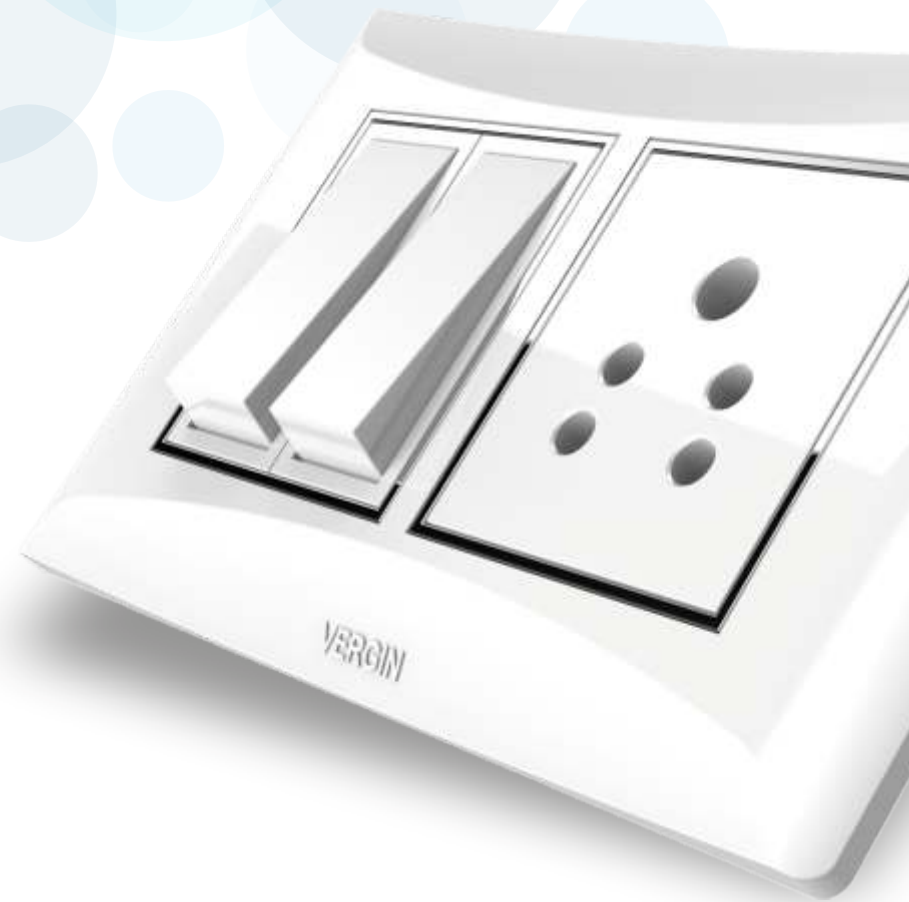

VION
MODULAR PLATES

SWITCH
& ACCESSORIES

AN ISO 9001:2015 CERTIFIED COMPANY
VERGIN
SWITCH & ACCESSORIES

TRENDY MODULAR SERIES

VION MODULAR PLATES

- White (Black Border)
- White (Silver Border)
- White (Golden Border)



VION
MODULAR PLATES

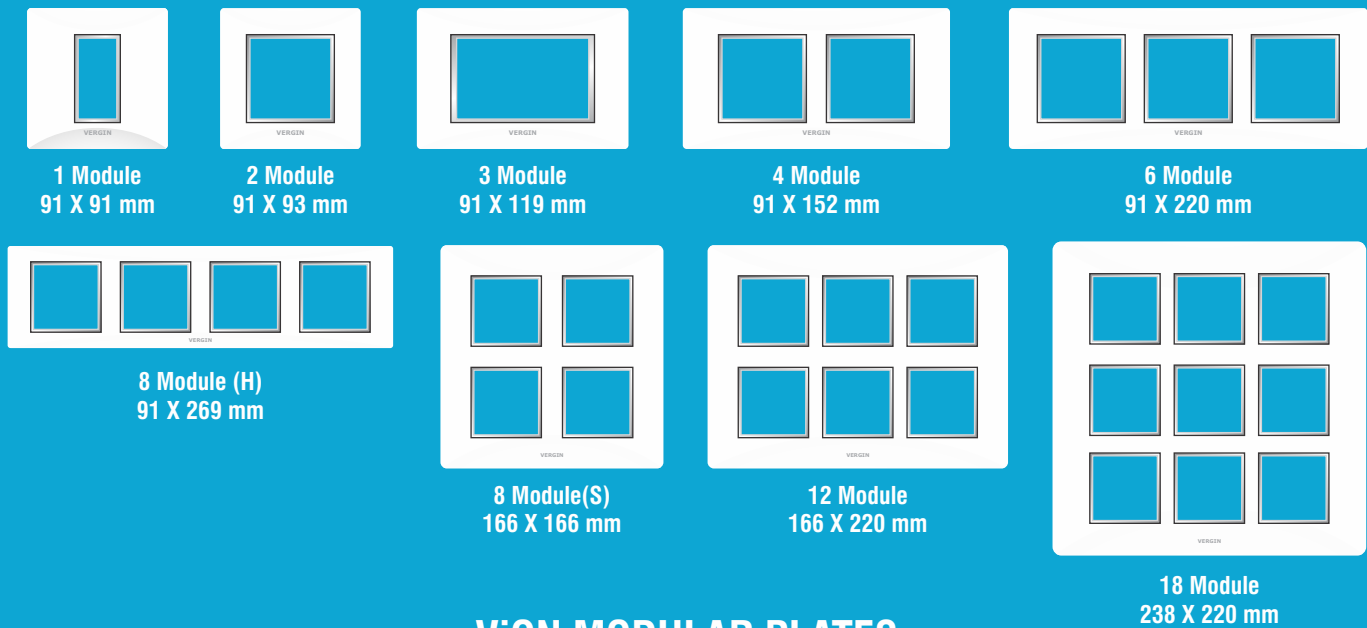

VION MODULAR PLATES

MODULE	1M	2M	3M	4M	6M	8M (Hz.)	8M (Sq.)	12M	16M	18M
CODE	5401	5402	5403	5404	5405	5406	5407	5408	5409	5410
WHITE (Black Border)	64.00	64.00	72.00	90.00	135.00	155.00	155.00	190.00	255.00	285.00
CODE	5411	5412	5413	5414	5415	5416	5417	5418	5419	5420
WHITE (Silver Border)	72.00	72.00	82.00	108.00	155.00	180.00	180.00	220.00	295.00	325.00
CODE	5421	5422	5423	5424	5425	5426	5427	5428	5429	5430
WHITE (Golden Border)	82.00	82.00	95.00	125.00	180.00	215.00	215.00	270.00	340.00	380.00
PKG.	10	10	10	10	10	10	10	10	10	10

Switch on
Something
Classic



Wood X
MODULAR PLATES

SWITCH
& ACCESSORIES



WOOD-X MODULAR PLATES

White

Wood X
MODULAR PLATES

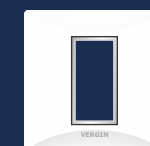

1 Module
91 X 91 mm

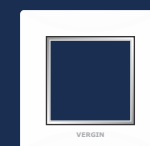

2 Module
91 X 93 mm



3 Module
91 X 119 mm



4 Module
91 X 152 mm



6 Module
91 X 220 mm



8 Module (H)
91 X 269 mm

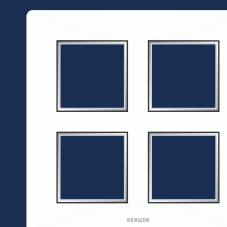

8 Module(S)
166 X 166 mm

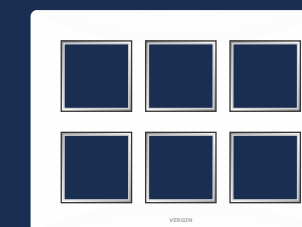

12 Module
166 X 220 mm

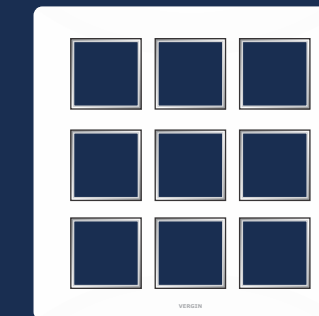

18 Module
238 X 220 mm

WOOD-X MODULAR PLATES

MODULE	1M	2M	3M	4M	6M	8M
CODE	5901	5902	5903	5904	5905	5906
WHITE	78.00	78.00	88.00	105.00	135.00	162.00
PKG.	10	10	10	10	10	10
MODULE	10M	12M (Hz.)	12M (Sq.)	16M	18M	20M
CODE	5907	5908	5908	5909	5910	5911
WHITE	175.00	295.00	218.00	275.00	325.00	335.00
PKG.	10	10	10	05	05	05

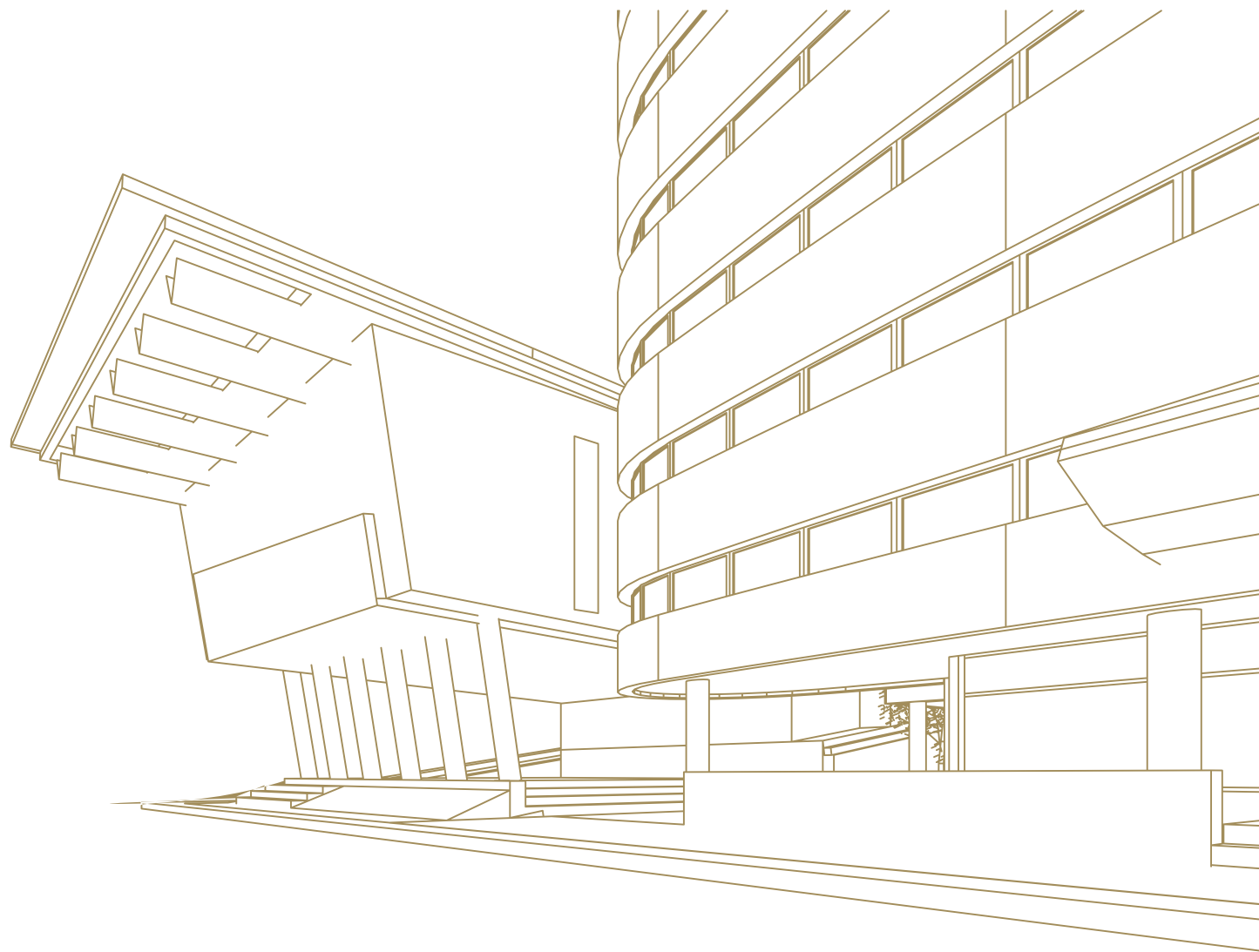

SWAGGER

Modular Series

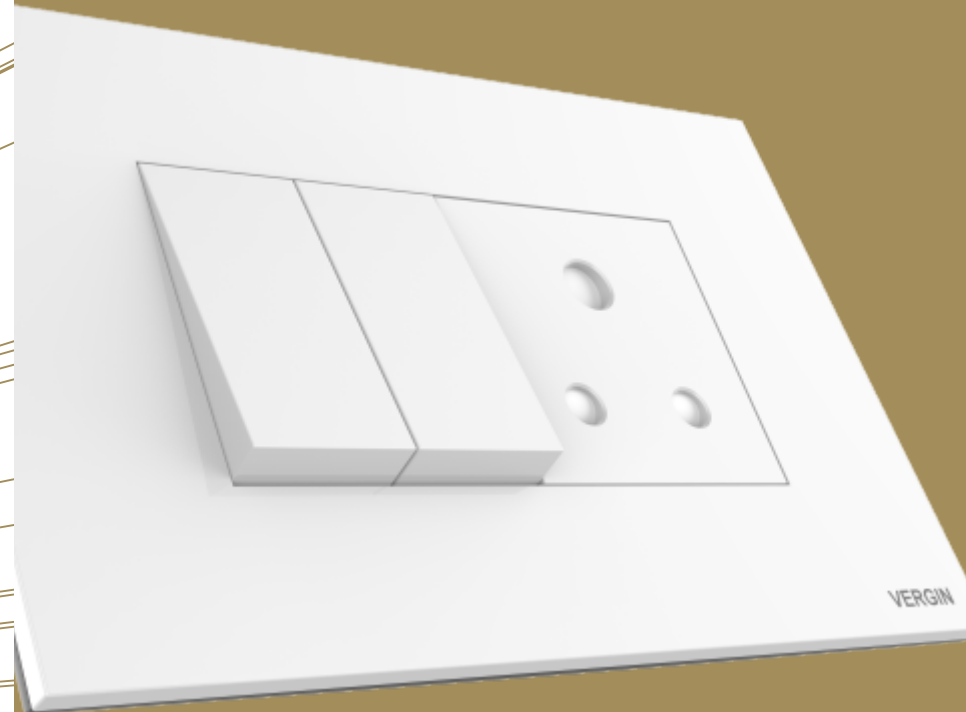

V-SOFT

SWITCHES

YOUR WORLD
AT YOUR FINGER TIPS



6001 6002 6003 6004

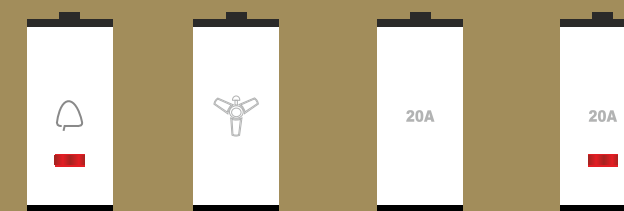

6005 6006 6007 6009



6011 6012 6013

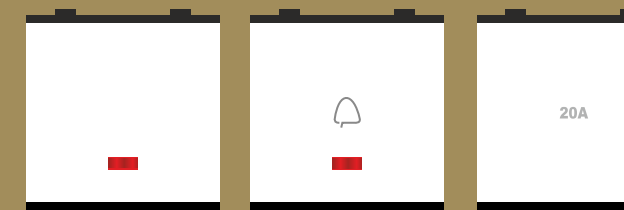

6014 6015 6016

CODE	DESCRIPTION	MRP	MRP	Pkg.
		WHITE	METALLIC GREY	
1 MODULE V-SOFT SWITCHES				
6001	10A. 1 Way Switch	74.00	82.00	20
6002	10A. 2 Way Switch	102.00	114.00	20
6003	10A. Bell Push Switch	102.00	114.00	20
6004	10A. 1 Way Switch with indicator	110.00	123.00	20
6005	10A. Bell Push with indicator	113.00	126.00	20
6006	10A. 1 Way Switch with Fan Mark	74.00	82.00	20
6007	20A. 1 Way Switch	114.00	129.00	20
6008	20A. 2 Way Switch	138.00	153.00	20
6009	20A. 1 Way Switch with indicator	147.00	171.00	20
2 MODULE V-SQUARE SWITCHES				
6011	10A. 1 Way Switch	113.00	130.00	10
6012	10A. 2 Way Switch	125.00	142.00	10
6013	10A. Bell Push Switch	153.00	171.00	10
6014	10A. 1 Way Switch with indicator	135.00	156.00	10
6015	10A. Bell Push with indicator	180.00	201.00	10
6016	20A. 1 Way Switch	153.00	174.00	10
6017	20A. 2 Way Switch	185.00	207.00	10
6018	20A. 1 Way Switch with indicator	201.00	222.00	10
6019	32A. 1 Way Switch with indicator	294.00	315.00	10

SWAGGER MODULAR SERIES

CODE	DESCRIPTION	MRP WHITE	MRP METALLIC GREY	Pkg.
6/16A. SOCKET OUTLETS				
6101	6A. 2 Pin Socket (1 Module)	84.00	100.00	10
6102	6A. Socket	129.00	154.00	10
6103	6A. Socket (With Shutter)	156.00	186.00	10
6104	6/25A. Universal Socket (With Shutter)	210.00	246.00	10

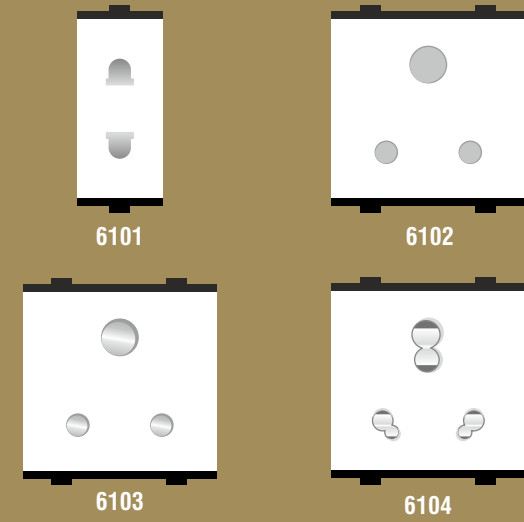

MODULAR ACCESSORIES				
6111	USB Charger	765.00	795.00	10
6112	Neon Indicator	93.00	111.00	20
6113	1 Module Blank Plate	27.00	39.00	60
6114	RJ 11 Tele Jack with shutter	120.00	141.00	20
6115	TV Single Socket	83.00	105.00	20
6116	Mini RJ 45 Jack (AT&T) CAT 6	705.00	744.00	10

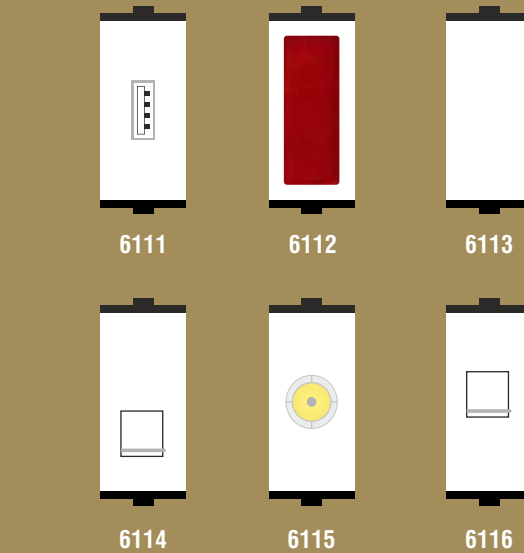

DIMMER & REGULATORS				
6121	Mini Dimmer	225.00	255.00	12
6122	4 Step Regulator	285.00	330.00	12
6123	5 Step Regulator	330.00	375.00	08

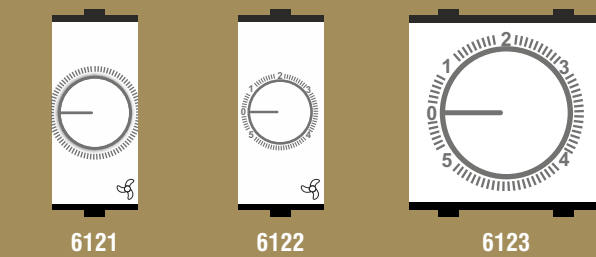

SWAGGER MODULAR SERIES

CODE	DESCRIPTION	MRP WHITE	MRP METALLIC GREY	Pkg.
MCB (Miniature Circuit Breaker) Heavy Duty				
6131	6A MCB SP	330.00	375.00	10
6132	10A MCB SP	330.00	375.00	10
6133	16A MCB SP	330.00	375.00	10
6134	20A MCB SP	330.00	375.00	10
6135	25A MCB SP	330.00	375.00	10
6136	32A MCB SP	330.00	375.00	10
6145	25A MCB DP	780.00	840.00	10
6146	32A MCB DP	780.00	840.00	10
6151	25A. Motor Starter	555.00	615.00	08



2M BUZZER & NIGHT LAMPS				
6161	Buzzer	225.00	255.00	10
6162	LED Night Lamp	270.00	300.00	10
6163	3LED Step Marker	270.00	300.00	10

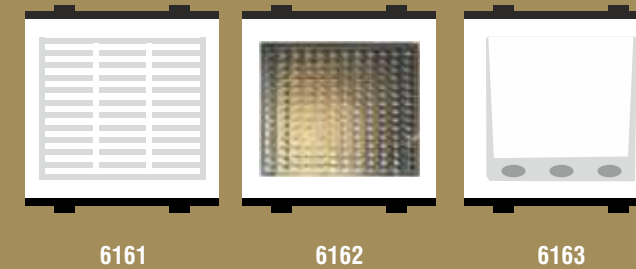

HOTEL KEY CARDS				
6171	32A DP Operated by Key Tag	465.00	525.00	10
6172	Only Key Tag	111.00	141.00	20



MAKE YOUR LIFE EASY

Royale

MODULAR PLATES



A Switch called
Luxury

SWITCH
& ACCESSORIES

AN ISO 9001:2015 CERTIFIED COMPANY



SWAGGER MODULAR SERIES

ROYALE MODULAR PLATES

White • Matt Grey

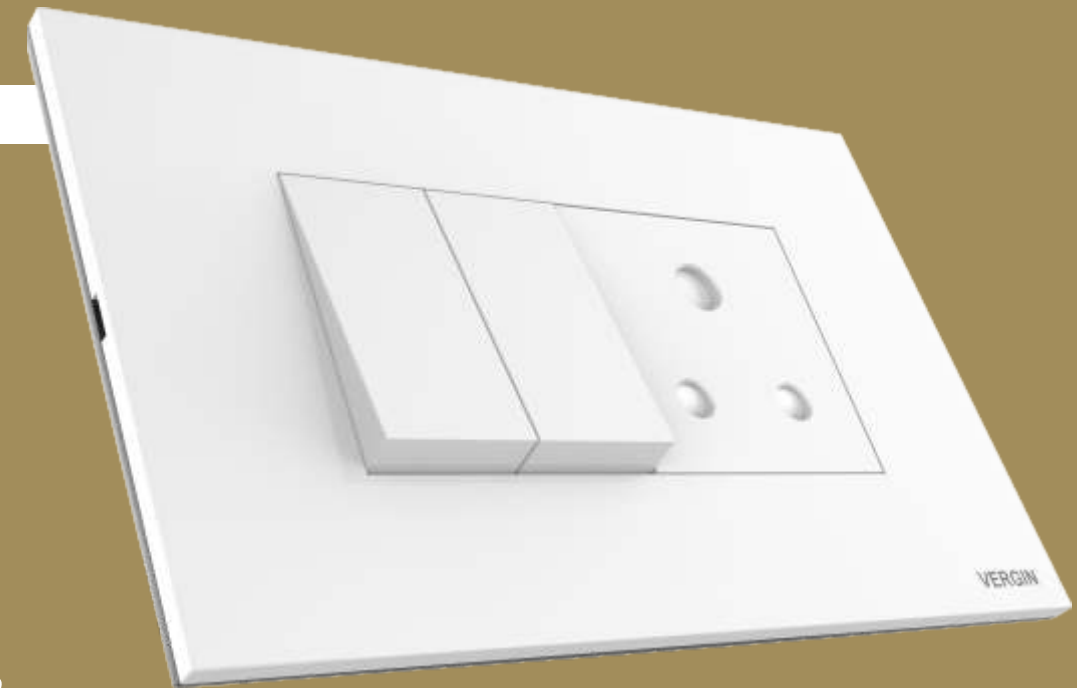

Royale

MODULAR PLATES

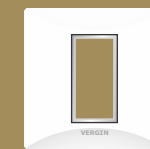

1 Module
91 X 91 mm

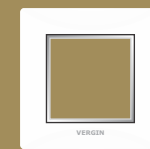

2 Module
91 X 93 mm

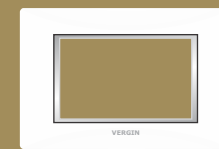

3 Module
91 X 119 mm

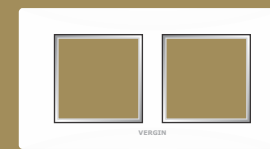

4 Module
91 X 152 mm

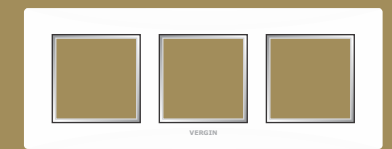

6 Module
91 X 220 mm



8 Module (H)
91 X 269 mm

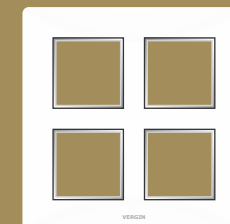

8 Module(S)
166 X 166 mm

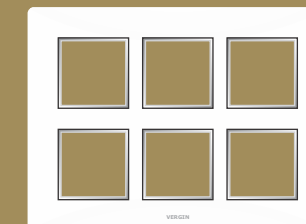

12 Module
166 X 220 mm

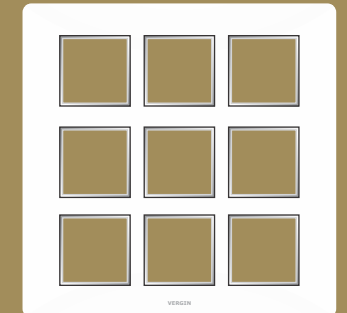

18 Module
238 X 220 mm

ROYALE MODULAR PLATES

MODULE	1M	2M	3M	4M	6M	8M (Hz.)	8M (Sq.)	12M	18M
CODE	6201	6202	6203	6204	6205	6206	6207	6208	6210
WHITE	93.00	93.00	120.00	135.00	186.00	240.00	250.00	300.00	378.00
CODE	6211	6212	6213	6214	6215	6216	6217	6218	6220
MATT GREY	129.00	129.00	162.00	186.00	261.00	315.00	330.00	420.00	525.00
PKG.	10	10	10	10	10	10	10	5	5



HOLDERS



CODE	PRODUCT	PKG.
1003A	Premium Holder (Angle)	20
1003B	Premium Holder (Batten)	20
1004A	Golden Ring Holder (Angle)	20
1004B	Golden Ring Holder (Batten)	20
1005A	Fancy Holder (Angle)	20
1005B	Fancy Holder (Batten)	20
1012A	5 x 5 Fancy Modular Holder (Angle)	10
1012B	5 x 5 Fancy Modular Holder (Batten)	10
1017	Conn Modular Flash Angle Holder	30
1018	BC Parellel	20
1023	Nova Pendant Holder (Black)	20
1024	Nova Pendant Holder (White)	20
1025	Nova Multi Pendant Holder (Black)	20
1026	Nova Multi Pendant Holder (White)	20
1027	Premium Multi Pendant Holder (White)	20
1029	Premium Skirt Pendant Holder (White)	20
1030	Premium Skirt Pendant Holder (Red)	20
1035	PC Adaptor	30



ACCESSORIES



CODE	PRODUCT	PKG.
1037	5 x 5 Modular Ceiling Rose	20
1039	Ceiling Rose	20
1040	Jumbo Ceiling Rose	20
1043	Deluxe 2 Pin (Male)	20
1044	Deluxe 2 Pin (Male-Female)	20
1045	Diamond 2 Pin (Male)	20
1046	Diamond 2 Pin (Male-Female)	20
1047	Premium 2 Pin (Male)	20
1048	Premium 2 Pin (Male-Female)	20
1049	Milo 2 Pin (Male)	20
1050	Milo 2 Pin (Male-Female)	20
1051	Eris 3 Pin Top (6 Amp.)	20
1052	Eris 3 Pin Top (16 Amp.)	10
1061	Dura Line Tester	100
1063	Deluxe 3 Pin Multiplug	20
1064	Premium 3 Way Multiplug	20
1066	Jumbo 6 to 16 Amp Multiplug	20
1068	1M Blank Plate	100
1070	5 x 5 Blank Plate	20
1071	5 x 7 Blank Plate	20
1073	PVC POP Round Sheet	40
1074	PVC POP Fan Sheet 7"	20
1087	PVC Concealed Box	900
1090	PVC Fan Box	160
1092	Bed Switch	20



FAN REGULATORS



CODE	PRODUCT	PKG.
1101	Switch Dimmer	20
1102	Socket Dimmer	15
1103	Switch 7 Step	20
1104	Socket 7 Step	15
1110	Switch Modular 7 Step	20
1111	Socket Modular 5 Step (Non-Humfree)	10
1112	Switch 4 Step (Humfree)	20
1114	Socket 5 Step (Humfree)	12
1121	Switch Mod. 4 Step (Humfree)	20
1123	Socket Mod. 5 Step (Humfree)	10
1129	Switch Mod. Nixon 4 Step (Humfree)	20
1131	Socket Mod. Nixon 5 Step (Humfree)	10
1133	Switch Mod. Cherry 4 Step (Humfree)	20
1134	Socket Mod. Cherry 5 Step (Humfree)	10
1135	Switch Mod. Silver 4 Step (Humfree)	20
1136	Socket Mod. Silver 5 Step (Humfree)	10
1140	Mini Open 7 Step	15
1142	Big Boss Regulator 5 Step	12
1143	Open 7 Step	12
1144	Open 5 Step (Humfree)	12
1145	Old Gold Regulator 7 Step	12
1151	Cooler Regulator 600w	20
1152	Cooler Regulator 1000w	20
1153	Cooler Regulator 1500w	20
1154	Cooler Regulator 2000w	20

600w : 1151 | 1500w : 1153
1000w : 1152 | 2000w : 1154



FOOT LIGHT, EXTENSION CORD



CODE	PRODUCT	PKG.
FOOT LIGHT		
1202	4 Module Nexus with Plate	12
1204	4 Module Acura with Plate	12
1225	6 Module Scenery with Plate 5 x 8	10

Available Colours White W. white Red Blue Green

EXTENSION CORD		
1270	Fabia Flex Box (2 Pin 4 Yard)	10
1271	Fabia Flex Box (2 Pin 7 Yard)	10
1272	Frizbee Flex Box (3 Pin 4 Yard)	10



MCB

Miniature Circuit Breaker
HEAVY DUTY



MCB



MCB DISTRIBUTION BOX

MINITURE CIRCUIT BREAKER "C" TYPE (MCB)

240/415 V AC 50 Hz SUPPLY (BREAKING CAPACITY 10KA)

LIGHTING SERIER	SP	SPN	DP	TP	TPN	FP
"C TYPE"	CODE	CODE	CODE	CODE	CODE	CODE
6 AMP	2811	2821	2831	2841	2851	2861
10 AMP	2812	2822	2832	2842	2852	2862
16 AMP	2813	2823	2833	2843	2853	2863
20 AMP	2814	2824	2834	2844	2854	2864
25 AMP	2815	2825	2835	2845	2855	2865
32 AMP	2816	2826	2836	2846	2856	2866
40 AMP	2817	2827	2837	2847	2857	2867
63 AMP	2818	2828	2838	2848	2858	2868
PKG.	12	06	06	04	03	03

RCCB / ELCB

240/415 V AC 50 Hz SUPPLY

	DP	FP
	CODE	CODE
32AMP / 30MA	2901	2911
32 AMP / 100MA	2902	2912
32 AMP / 300MA	2903	2913
40 AMP / 30MA	2904	2914
40 AMP / 100MA	2905	2915
40 AMP / 300MA	2906	2916
63 AMP / 30MA	2907	2917
63 AMP / 100MA	2908	2918
63 AMP / 300MA	2909	2919
PKG.	06	03

ISOLATORS

240/415 V AC Hz SUPPLY

REGULAR	DP	FP
	CODE	CODE
40 AMP	2871	2881
63 AMP	2872	2882
100 AMP	2873	2883
PKG.	06	03

DP INCLOSER

240/415 V AC 50 Hz SUPPLY

	DP
	CODE
32 AMP	2900
PKG.	10

DRACO



SINGLE PHASE
DOUBLE DOOR DB'S

CODE	PRODUCT	PKG.
DRACO SINGLE PHASE DOUBLE DOOR DB'S		
1464	Draco Single Phase Double Door Db's 4	01
1465	Draco Single Phase Double Door Db's 6	01
1466	Draco Single Phase Double Door Db's 8	01
1467	Draco Single Phase Double Door Db's 12	01

PLATINUM MCB

1446	Platinum 2-4 Way	01
1447	Platinum 6-8 Way	01
1448	Platinum 10-14 Way	01

PLATINUM



PLATINUM MCB

AQUA PVC MCB

1455	Aqua PVC 1-2 Way	20
1456	Aqua PVC 3-4 Way	12



PVC AQUA



GANG BOX, METER

CODE PRODUCT PKG.

Yuva Modular Gang Box



YUVA
Modular Gang Box

1751	1 Module	10
1752	2 Module	10
1753	3 Module	10
1754	4 Module	10
1755	6 Module	05
1756	8 Module Hz	05
1757	8 Module Sq	05
1758	12 Module	05
1759	16 Module	05
1760	18 Module	05

ANTI-TEMPER STATIC K.W.H. METER

1441	Anti-Tamper Static K.W.H. Meter Counter	01
1442	Anti-Tamper Static K.W.H. Meter Digital	01



1 Module



2 Module



3 Module

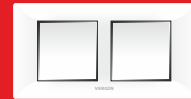

4 Module

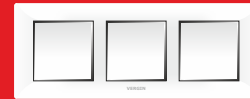

6 Module



8 Module Hz

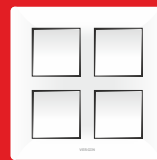

8 Module Sq

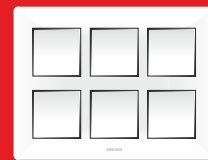

12 Module

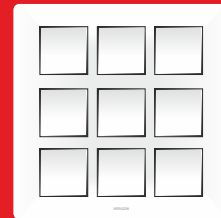

18 Module



1441



1442



CONCEALED BOX

METAL CONCEALED BOX

LEO 0.9 Guage	BHIM 1.2 Guage	Module	Pkg.
1481	1491	1-2 Module	96 Pcs.
1482	1492	3 Module	72 Pcs.
1483	1493	4 Module	56 Pcs.
1484	1494	6 Module	36 Pcs.
1485	1495	8 Module Hz.	32 Pcs.
1486	1496	8 Module Sq.	28 Pcs.
1487	1497	12 Module	18 Pcs.
1488	1498	16 Module	15 Pcs.
1489	1499	18 Module	15 Pcs.

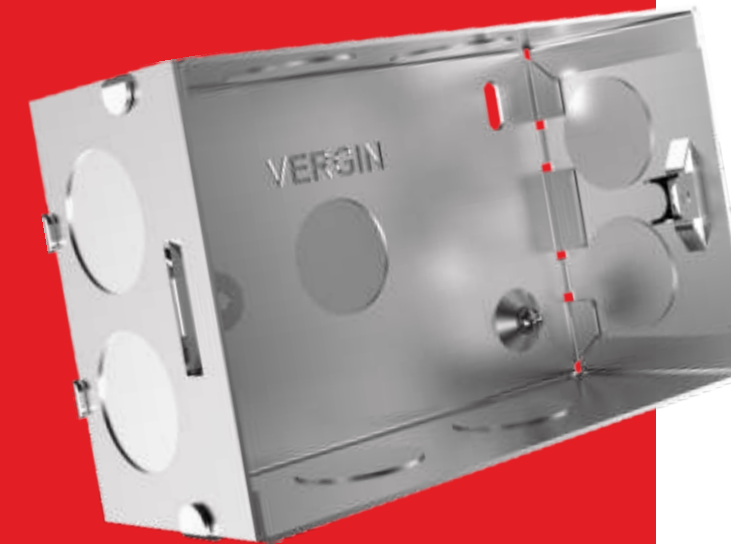

PVC CONCEALED BOX

BLACK	Module	Pkg.
1471	1-2 Module	20
1472	3 Module	20
1473	4 Module	20
1474	6 Module	20
1475	8 Module Hz.	20
1476	8 Module Sq.	20
1477	12 Module	10
1478	16 Module	10
1479	18 Module	10



DEEP JUNCTION BOX LED LIGHTS

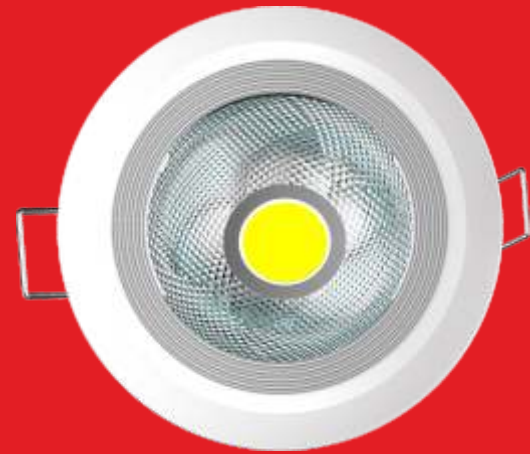

MARVEL
Deep Junction Light

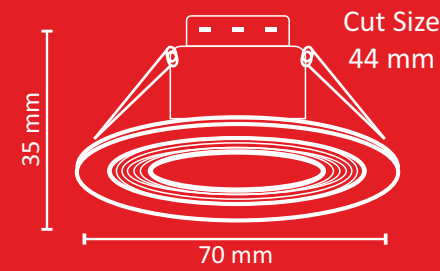

Code	Watt	Available Colours
3070	4W	Single Colour
		Cool White, Warm White, Red, Green, Blue, Pink
		Tri Colour
		Red + Blue + Purple, White + Warm White + Natural White

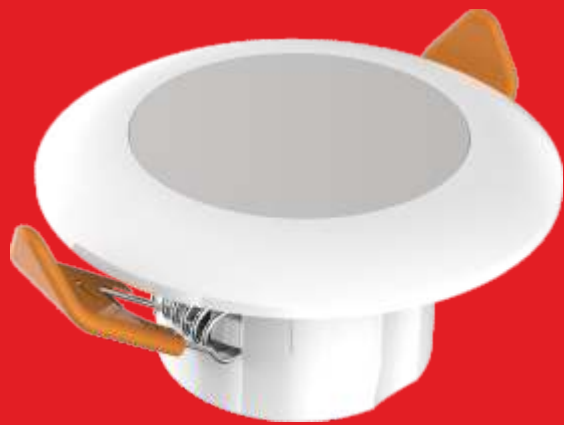

Alexa

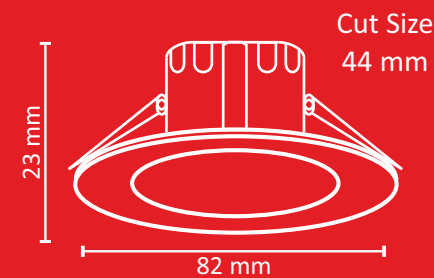

Code	Watt	Available Colours
3071	4W	Single Colour
		Cool White, Warm White, Red, Green, Blue, Pink
		Tri Colour
		Red + Blue + Purple, White + Warm White + Natural White



MIRA

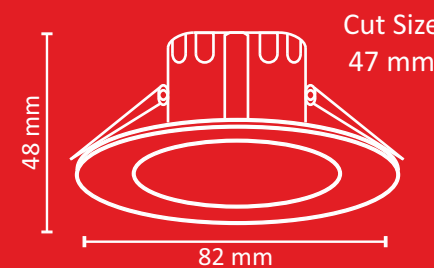

Code	Watt	Available Colours
3072	4W	Single Colour
		Cool White, Warm White, Red, Green, Blue, Pink
		Tri Colour
		Red + Blue + Purple, White + Warm White + Natural White

JUNCTION BOX LED LIGHTS

RANGOLI
JUNCTION LED LIGHT

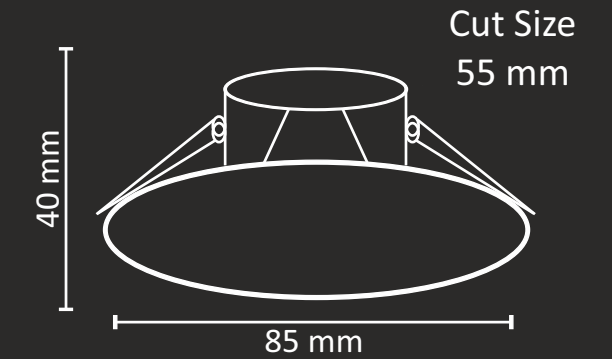
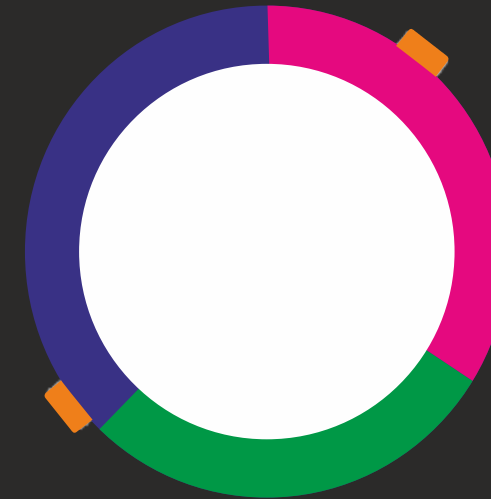

Code	Watt	Available Colours
3069	7+7W	White + PGB

RIO

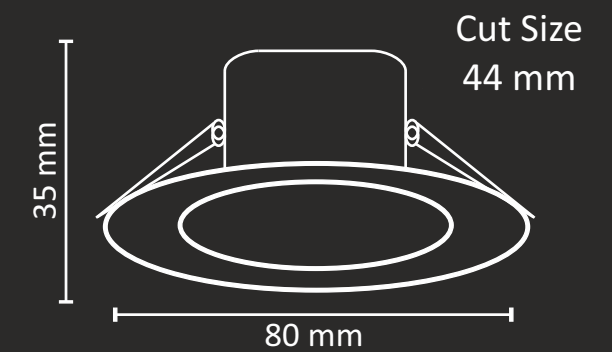
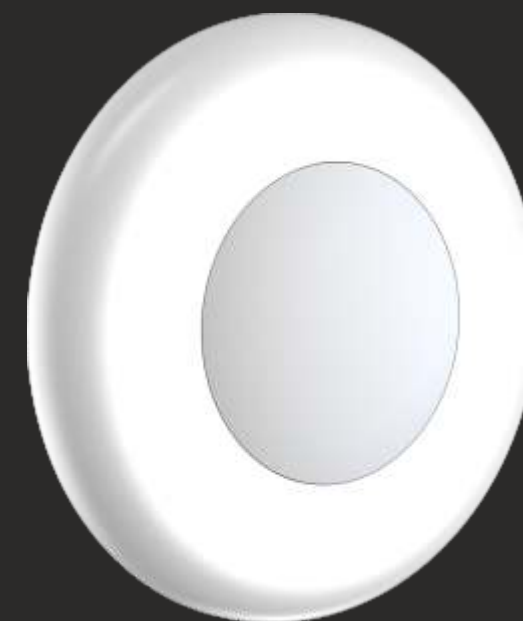

Code	Watt	Available Colours
3073	4W	Single Colour
		Cool White, Warm White, Red, Green, Blue, Pink
		Tri Colour
		Red + Blue + Purple, White + Warm White + Natural White

CONCEALED BOX LED LIGHTS

FIGO+

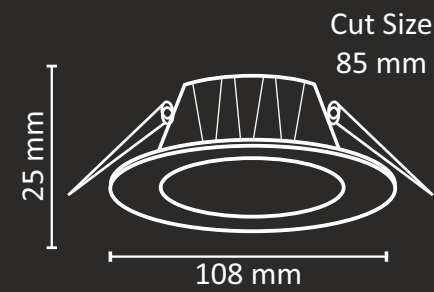

Code	Watt	Available Colours
3075	7W	Single Colour
		Cool White, Warm White, Red, Green, Blue, Pink
		Tri Colour
		Red + Blue + Purple, White + Warm White + Natural White

HECTOR

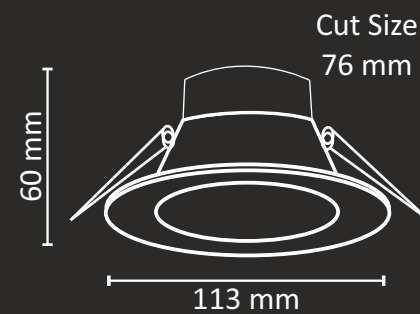
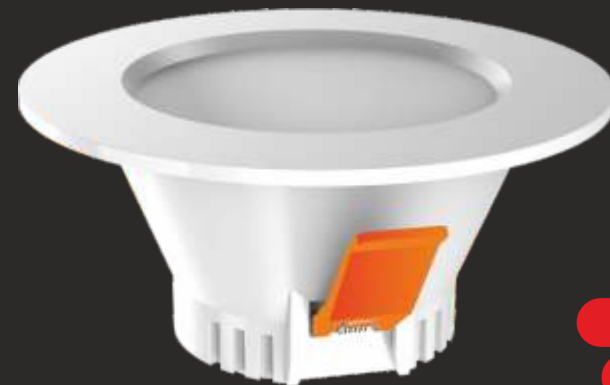

Code	Watt	Available Colours
3083	7W	Single Colour
		Cool White, Warm White, Red, Green, Blue, Pink
		Tri Colour
		Red + Blue + Purple, White + Warm White + Natural White

CONCEALED BOX LED LIGHTS

Amazia

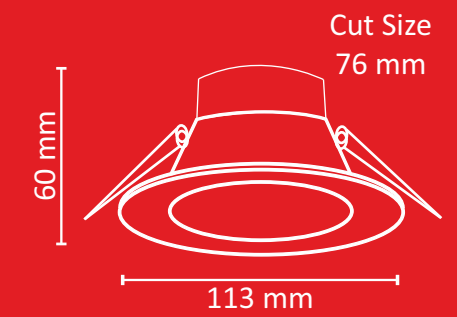

Code	Watt	Available Colours
3077	9W	Single Colour
		Cool White, Warm White, Red, Green, Blue, Pink
		Tri Colour
		Red + Blue + Purple, White + Warm White + Natural White

RANGOLI
CONCEALED LED LIGHT

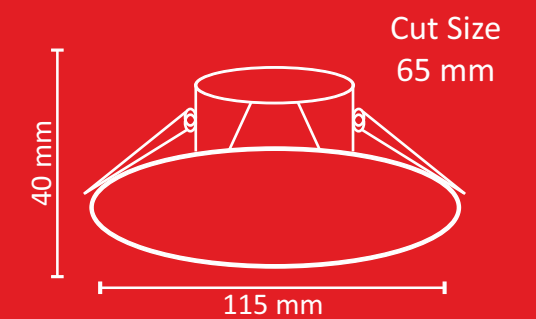
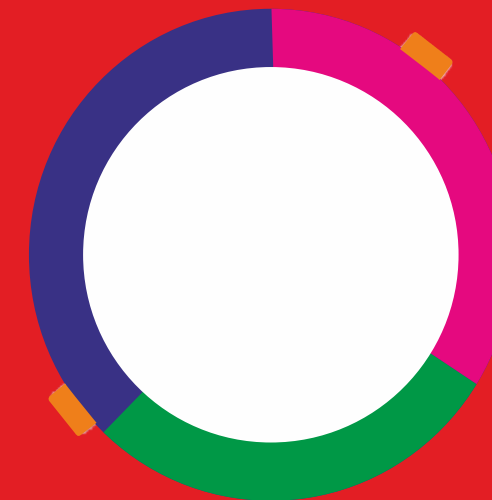

Code	Watt	Available Colours
3089	15+15W	White + PGB

LED PANEL LIGHTS

CURVE

METAL SLIM PANEL LIGHT



Code	Watt	Panel Size (mm)	Panel Cut-out (mm)
3097	8W	120 mm (5")	105 mm (4")
3098	15W	170 mm (7")	155 mm (6")
3099	22W	225 mm (9")	205 mm (8")

Available Colours : Cool White 6500K

Code	Watt	Panel Size (mm)	Panel Cut-out (mm)
3102	8W	120 mm (5")	105 mm (4")
3103	15W	170 mm (7")	155 mm (6")
3104	22W	225 mm (9")	205 mm (8")

METAL SLIM PANEL



Available Colours : Cool White 6500K

LED PANEL LIGHTS

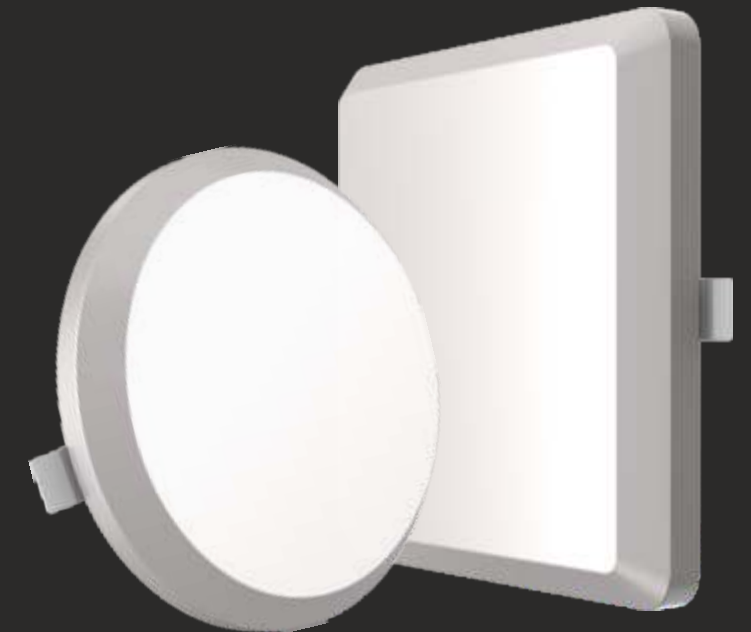
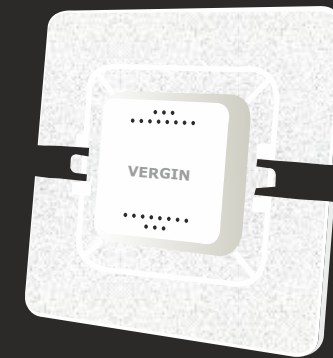

Code	Watt	Panel Size (mm)	Panel Cut-out (mm)
3125	8W	114 mm (4.5")	71 mm (3")
3126	15W	152 mm (6")	107 mm (4.5")
3127	22W	190 mm (7.5")	140 mm (5.5")

Available Colours : Cool White 6500K • Warm White 4000K • Natural White 5000K

Available Tri-Colour : Cool White + Warm White + Natural White

ZERO BORDER

RENAULT

DEEP DOWNLIGHT PANEL LIGHT (PVC)



Code	Watt	Panel Size (mm)	Panel Cut-out (mm)
3161	8W	105 mm (4")	95 mm (4")
3162	15W	135 mm (5")	125 mm (5")
3163	20W	155 mm (6")	145 mm (6")

Body Colour
White - Black

Available Colours : Cool White 6500K • Warm White 4000K • Natural White 5000K

Available Tri-Colour : Cool White + Warm White + Natural White

Code	Watt	Size
3128	40W	2ft X 2ft

BIG GLOW SLIM PANEL



Available Colours : Cool White 6500K • Warm White 4000K • Natural White 5000K

LED PANEL & SURFACE LIGHTS

Code	Watt	Panel Size (mm) (inches)	Panel Cut-out (mm) (inches)
3131	8W	115 mm (4.5")	105 mm (4")
3131	8W (3in1)	115 mm (4.5")	105 mm (4")
3132	15W	145 mm (5.5")	137 mm (5")
3132	15W (3in1)	145 mm (5.5")	137 mm (5")
3130	15W	165 mm (6.5")	155 mm (6")
3130	15W (3in1)	165 mm (6.5")	155 mm (6")
3133	22W	215 mm (8.5")	205 mm (8")
3133	22W (3in1)	215 mm (8.5")	205 mm (8")

SLEEK SLIM PANEL



Available Colours : Cool White 6500K • Warm White 4000K • Natural White 5000K

Available Tri-Colour : Cool White + Warm White + Natural White

SLEEK SURFACE FRAME

Code	Inch
3131	4"
3132	5"
3133	6"

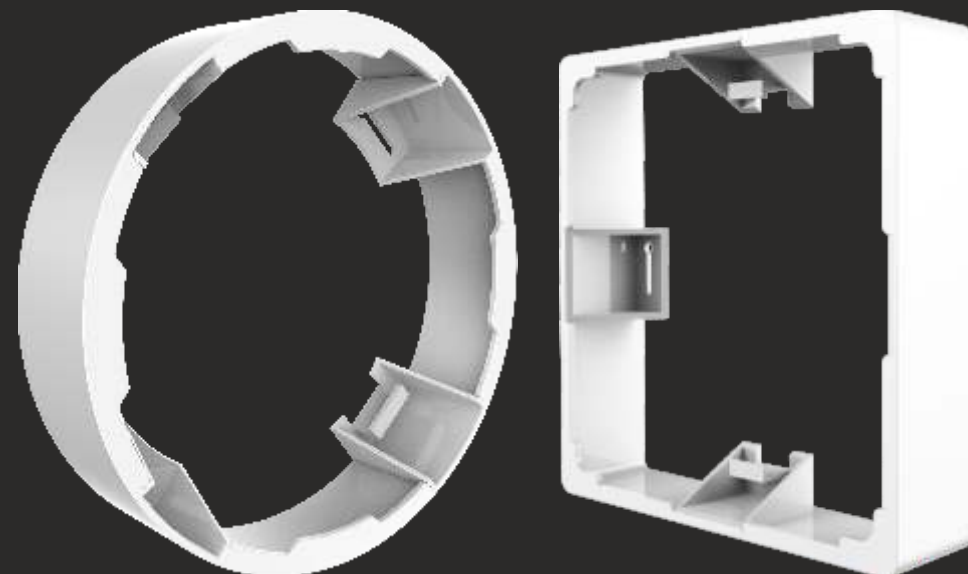

LED PANEL & SURFACE LIGHTS

Dazzle LED PANEL LIGHT

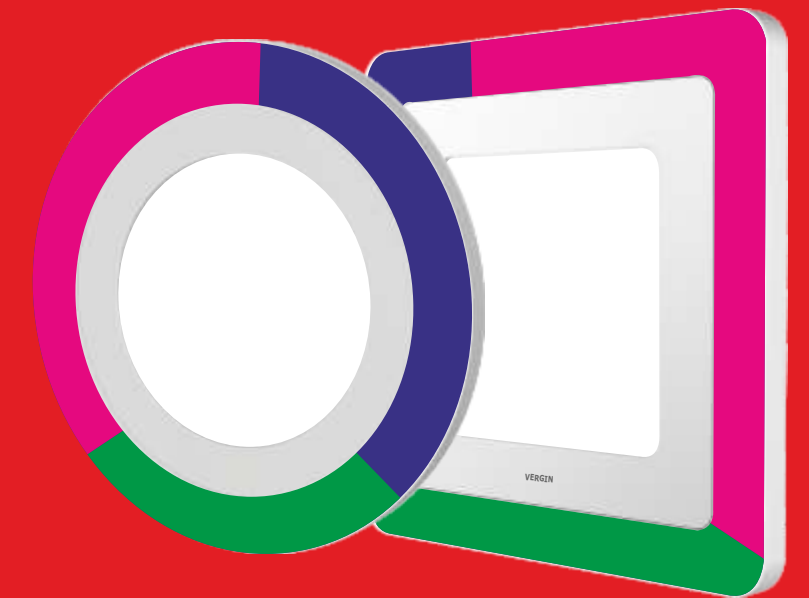

Code	Watt	Panel Size (mm)	Panel Cut-out (mm)
3145	3+3W	105 mm (4.5")	90 mm (3.5")
3146	6+4W	145 mm (6")	120 mm (5")
3147	12+4W	195 mm (8")	160 mm (7")

Available Dual-Colours : Cool White + PGB

Dazzle SURFACE LED LIGHT



Code	Watt	Surface Size
3145	3+3W	105 mm (4.5")
3146	6+4W	145 mm (6")
3147	12+4W	195 mm (8")

Available Dual-Colours : Cool White + PGB

LED SURFACE LIGHTS

Groom

FLAT SURFACE LIGHT



Code	Watt	Surface Size (mm)
------	------	-------------------

3134	8W	110 mm (4.5")
------	----	---------------

3135	15W	140 mm (5.5")
------	-----	---------------

Available Colour : Cool White 6500K

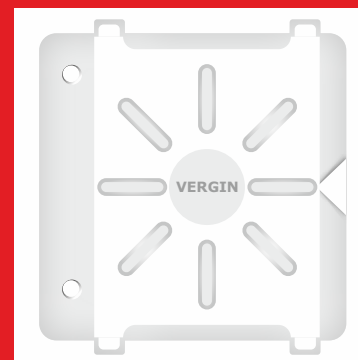

OREO

TRIMLESS LED SURFACE LIGHT

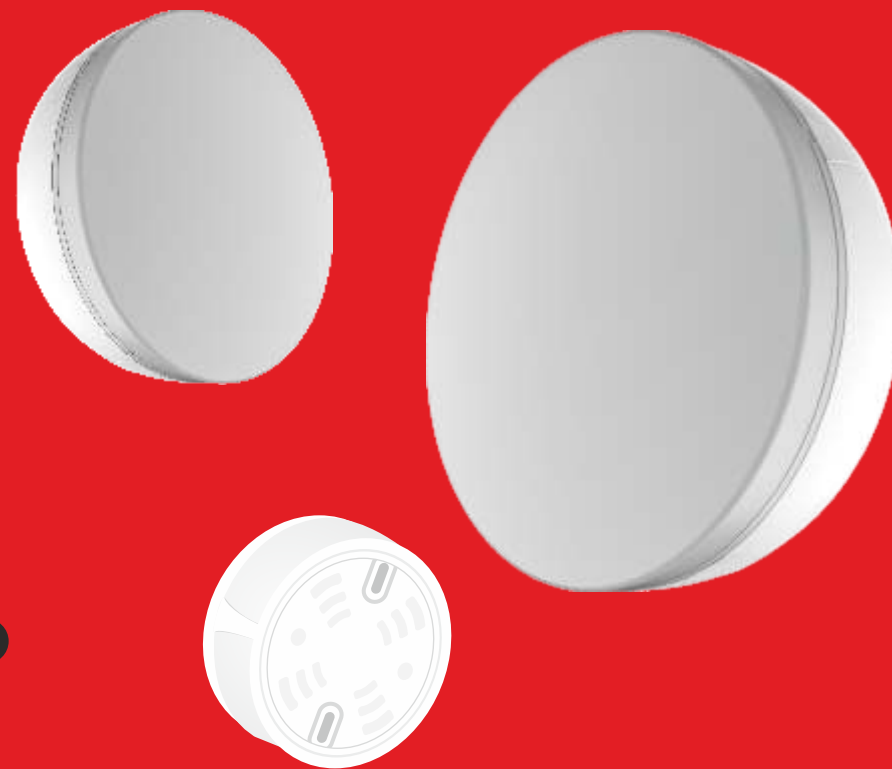

Code	Watt	Surface Size
------	------	--------------

3109	8w	83 mm (3.5")
------	----	--------------

3110	15w	140 mm (5.5")
------	-----	---------------

Available Colour : Cool White 6500K

Available Tri-Colour Red + Blue + Purple

STRIKER & SPOT

POLO & FRIZZ

LED STRIKER



Code	Watt	Panel Size
------	------	------------

3118	POLO 3W (Single Colour)	63 mm (2.5")
------	-------------------------	--------------

3119	POLO 3W (3 in 1 Color)	63 mm (2.5")
------	------------------------	--------------

3078	FRIZZ 6W (Single Colour)	82 mm (3")
------	--------------------------	------------

3079	FRIZZ 10W (Single Colour)	120 mm (5")
------	---------------------------	-------------

Available Colours : Cool White, Warm White, Red, Green, Blue, Pink

Available Tri Colour : Red + Blue + Purple,
White + Warm White + Natural White

BRIGHT 'N' SHINE

Code	Watt	Panel Size
------	------	------------

3081	6+3W	82 mm (3")
------	------	------------

3082	10+4W	120 mm (5")
------	-------	-------------

Available Dual-Colours : Cool White+Blue, Cool White+Red,
Cool White+Pink, Cool White+Green



Mini Pot

2W SPOT LIGHT

Code	Watt	Available Colours
------	------	-------------------

3151	2W	Single Colour
------	----	---------------

Cool White, Warm White, Red, Green, Blue, Pink



LED BULBS

Code	Watt	Available Colours
------	------	-------------------

3219	7w	Cool White
3220	9w	Cool White
3221	12w	Cool White
3222	15w	Cool White
3217	20w	Cool White
3218	25w	Cool White
3223	30w	Cool White
3224	50w	Cool White



Brighto
LED BULB

T5 & T8 LED BATTEN

AURA
T5 LED TUBE LIGHT



Code	Watt	Feet	Available Colours
3170	5W	1 Feet	Cool White
3171	10W	2 Feet	Cool White
3172	20W	4 Feet	Cool White

ReChargeable
LED BULB



UPTO
4Hrs.
Backup

Code	Watt	Available Colours
3227	10W	Cool White



Code	Watt	Available Colours
3182	26w	Cool White

BULLET
26w PVC T5
Tubelight



NEO
0.5 Watt LED Bulb

Code	Watt	Available Colours
3215	0.5W	Single Colour
		Cool White, Warm White, Red, Green,
		Blue, Pink, Orange, Yellow, RGB

Tesla
Aluminium T8
Tubelight

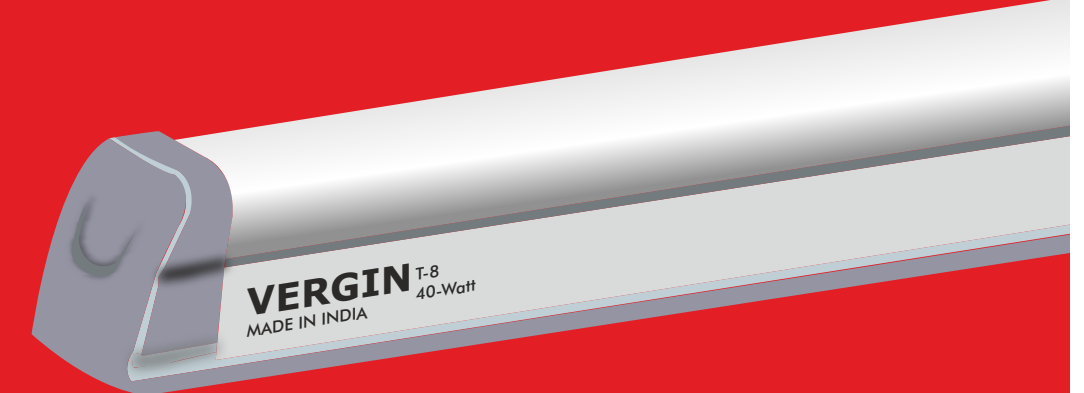

Code	Watt	Available Colours
3184	40w	Cool White

COB LIGHTS



Code	Watt	Panel Size (mm) (inches)	Panel Cut-out (mm) (inches)
3316	7w	65 mm	55 mm
3317	12w	85 mm	75 mm
3318	18w	95 mm	85 mm

Available Colour : Cool White 6500K, Warm White 4000K, Natural White 5000K

FIONA

COB Light

Body Colour
White - Black

GLORY

Cylinder LED Light

CYLINDER LIGHT

Code	Watt	Size
3351	7w	53x70 mm
3352	12w	73x90 mm
3353	18w	95 x 98 mm

Available Colour : Cool White 6500K, Warm White 4000K, Natural White 5000K



LED STRIPS LIGHT 240 LED

Code	Watt	Product	Length	Colours
3255	12W / MTR	2835 - 240 LED	5 MTR / 16 FEET	 Cool White  Warm White  Natural White

NEW ULTRABRIGHT SHADES

LED STRIPS

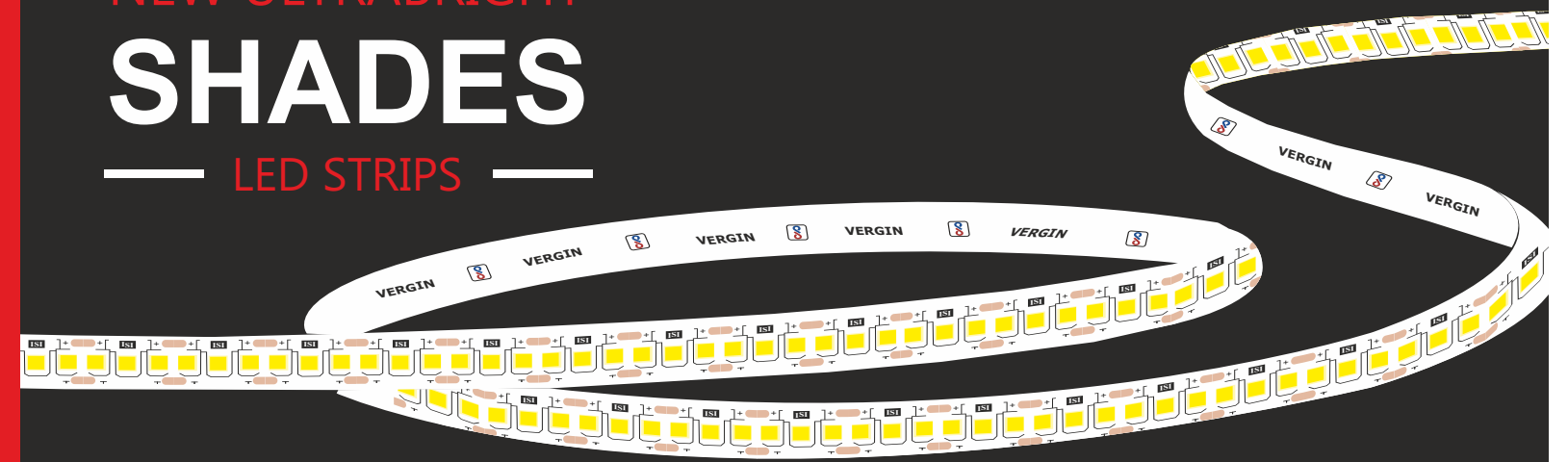

SMD LED ROPE LIGHT 120 LED

Code	Length	Colours
3250	50 MTR	WW - Blue - Pink - Green - Amber

Code	Watt
3341	6-8W
3342	9-24W

INDOOR LED LIGHT DRIVER



LED STRIPS DRIVERS/SMPS

Code	Watt	AMPS
3381	24W	2 AMP
3382	36W	3 AMP
3383	60W	5 AMP

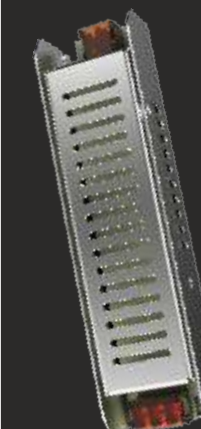

STREET LIGHTS



TOWER

STREET LIGHT

Code	Watt	Available Colours
3005	24w	Cool White
3006	36w	Cool White
3007	50w	Cool White



CRYSTAL

STREET LIGHT

Code	Watt	Available Colours
3015	24w	Cool White
3016	36w	Cool White
3017	50w	Cool White
3018	100w	Cool White
3019	150w	Cool White
3020	200w	Cool White

STREET LIGHTS & ACCESSORIES

STELA

STREET LIGHT



Code	Watt	Available Colours
3010	24w	Cool White
3011	36w	Cool White
3012	60w	Cool White
3013	100w	Cool White
3014	150w	Cool White

45° SL Wall Stand

Wall Clamp



3305



3303

360° Adjustable Wall Stand



Product	Code	Size	Description
45° Wall Stand	3302	1.25" (30mm)	MS GOLDEN PIPE
45° Wall Stand	3303	1.5" (40 mm)	MS GOLDEN PIPE
360° Adj. Stand	3304	PVC Unbreakable	ABC PVC
Wall Clamp	3305	1.5 MM	MS STEEL METAL

FLOOD LIGHTS



Code	Watt	Available Colours
3051	50w	Cool White, Warm White
3052	100w	Cool White

unique
FLOOD LIGHT



Code	Watt	Available Colours
3047	50w	Cool White
3048	100w	Cool White
3049	150w	Cool White
3050	200w	Cool White

Ujjwal
FLOOD LIGHT

INDUSTRIAL HAY BAY LED LIGHTS

MARCUS HAY BAY

2835 LED

Code	Watt	Approx Range
3063	50w	Upto 40 Feet
3064	60w	Upto 40 Feet
3065	100w	Upto 40 Feet
3066	120w	Upto 40 Feet
3067	150w	Upto 40 Feet
3068	200w	Upto 40 Feet



POWER LED 5050

Code	Watt	Approx Range
3060	120w	Upto 100 Feet
3061	150w	Upto 150 Feet
3062	200w	Upto 200 Feet

STADIUM Light

Code	Watt	Approx Range
3058	400w	Upto 300 Feet
3059	500w	Upto 300 Feet

Special Design for Box Cricket Ground



WIRE'S THAT STAYS LONG LASTING

CORAL



MULTI STRAND PVC INSULATED BUILDING WIRES (Flame Retardant Low Smoke)

Code	Nominal Area (Sq. mm)	Description (Sq. mm)	Current Rating in Amp.	Length in Mtrs.	Carton Packing
4110	0.75	10/0.30	7	90	24
4111	1.0	14/0.30	11	90	24
4112	1.5	22/0.30	14	90	20
4113	2.5	36/0.30	19	90	12
4114	4.0	56/0.30	26	90	08
4115	6.0	84/0.30	34	90	10

WIRE'S THAT STAYS LONG LASTING

Classy



MULTI STRAND PVC INSULATED BUILDING WIRES (Flame Retardant Low Smoke)

Code	Nominal Area (Sq. mm)	Description (Sq. mm)	Current Rating in Amp.	Length in Mtrs.	Carton Packing
4010	0.75	10/0.30	7	90	24
4011	1.0	14/0.30	11	90	24
4012	1.5	22/0.30	14	90	20
4013	2.5	36/0.30	19	90	12
4014	4.0	56/0.30	26	90	08



56 CM/L-8583797

AN ISO 9001:2015 CERTIFIED COMPANY



WIRES & CABLES

Multi Core Round Wires



0.5 Sq. mm. (16/0.20) 4 Amps

Code	Core	Length
4051	2 Core	90 Meter
4052	3 Core	90 Meter

1.5 Sq. mm. (30/0.20 14/0.30) 14 Amps

Code	Core	Length
4066	2 Core	90 Meter
4067	3 Core	90 Meter
4068	4 Core	90 Meter

0.75 Sq. mm. (24/0.20 11/0.30) 7 Amps

Code	Core	Length
4056	2 Core	90 Meter
4057	3 Core	90 Meter

2.5 Sq. mm. (50/0.20 36/0.30) 19 Amps

Code	Core	Length
4071	2 Core	90 Meter
4072	3 Core	90 Meter
4073	4 Core	90 Meter

1.0 Sq. mm. (32/0.20 14/0.30) 11 Amps

Code	Core	Length
4061	2 Core	90 Meter
4062	3 Core	90 Meter

4.0 Sq. mm. (56/0.30) 26 Amps

Code	Core	Length
4076	3 Core	90 Meter
4077	4 Core	90 Meter

AN ISO 9001:2015 CERTIFIED COMPANY



WIRES & CABLES

Aluminum Service Wire

Code	Core	Guage	Length
4141	2.5 Sq. mm	56	90 Meter
4142	4 Sq. mm	75	90 Meter
4143	6 Sq. mm	96	90 Meter
4144	10 Sq. mm	120	90 Meter



55



Trips & Events



Electrician Friendly

AN ISO 9001:2015 CERTIFIED COMPANY



Behind The Scene

WARRANTY CONDITION

This Warranty applies to all Products sold by VERGIN (the "Products"); Provided, however that the term Products does not include any third Party Products Purchased through VERGIN, For Which no Warranties are Made (the "Third Party Products"). Third Party Products may be Subject to a Separate Manufacture's Warranty NOTICE : READ THIS LIMITATION OF WARRANTY AND LIABILITY BEFORE BUYING OR USING THE PRODUCTS CONTAINED HEREIN. It is impossible to eliminate all risks associated with the use of the Products. Risks of Serious injury or Death, Including risks Associated with Electrocution, Arcing & Thermal Burns, are Inherent in work in and Around Energized Electrical Systems. Such Risks Arise from the Wide Variety of Electrical Systems & Equipment to Which Products may be Applied, the manner of use or Application, Weather & Environmental conditions or Other Unknown Factors, all of Which are beyond the control of VERGIN. VERGIN does not agree to be an Insurer of These Risks, & Shall Have no Liability for Any Claims Arising from such Risks.

WHEN YOU BUY OR USE THESE PRODUCTS, YOU AGREE TO ACCEPT THESE RISKS.

LIMITATIONS

- This Warranty is void in the event of Misuse, alteration, faulty installation, or misapplication of the Product.
- This Warranty does not cover failure of product or components due to any ACT OF NATURE : Lightning, Floods, Hurricanes, Tornadoes or any Other such Catastrophic Events.
- VERGIN Does not Warrant any Third Party Products or associated Hardware or Their Performance or Suitability for Use & Application. Such Items are Provided "as-is".
- VERGIN is not Required to make Replacement or Loaner Equipment available while Products are being repaired or Replaced, or to Compensate you for any in/out Labor Charges or Expenses associated with removal, handling or re-installation of the Products.
- To the Maximum extent permitted by law, this Warranty and the Remedies set forth are Exclusive & in lieu of All Other Warranties, Remedies & Conditions, Whether Oral or Written, express or implied. VERGIN EXPRESSLY DISCLAIMS ALL OTHER WARRANTIES OF ANY KIND EXPRESS OR IMPLIED, INCLUDING WITHOUT LIMITATIONS IMPLIED WARRANTIES OF FITNESS FOR A PARTICULAR PURPOSE, MERCHANTABILITY AND NON-INFRINGEMENT.
- IN NO EVENTS SHALL VERGIN BE LIABLE FOR ANY INDIRECT, INCIDENTAL, CONSEQUENTIAL OR SPECIAL DAMAGES RESULTING FROM THE USE OR HANDLING OF THESE PRODUCTS. THIS SHALL INCLUDE BUT, NOT LIMITED TO, LOST PROFITS OR REVENUE, LOSS OF USE OF THE PRODUCTS, COST OF SUBSTITUTE PRODUCTS FACILITIES OR SERVICES, OR DOWNTIME.
- IN NO EVENT SHALL VERGIN HAS ANY LIABILITY FOR ANY THIRD PARTY PRODUCTS OR ASSOCIATED HARDWARE, OR CUSTOMER-OWNED SYSTEMS, EQUIPMENT OR SOFTWARE.

VERGIN must Have Prompt notice of any Claim so that an immediate Product inspection and investigation can be made. Buyer and all Users shall Promptly notify VERGIN of any Claims, Whether Based on Contract, Negligence, Strict Liability, or other tort or otherwise be barred from any remedy.

INTERNATIONAL CERTIFICATE



NATIONAL CERTIFICATE

